



Serving the Veterinary Industry Since 1984

# Ultima 500 Series Owner's Manual



U 500 I Complete



U 500 II Complete

[www.Ultima Dental Systems.com](http://www.Ultima Dental Systems.com)  
Technical Support (954) 772-9779



Serving the Veterinary Industry Since 1984

Congratulations on the purchase of your new Ultima 500 air dental delivery unit. Our goal at Ultima Dental Systems is to provide the veterinarian with the finest dental products and the best customer support available in the industry. All of our equipment is built with a close attention to detail and a strong passion for quality. Ultima Dental Systems has specialized in dental air equipment exclusively for veterinarians since 1984 when we introduced the first veterinarian dental unit. Ultima Dental Systems is also the first dental manufacturer to introduce an enclosed dental cart system as well a dental unit with a built in wet table. We have offered quality products and services for nearly the past three decades. So you can rest assured that you have purchased the finest veterinary dental Equipment available in the world today.

\*Your Ultima 500 unit has been set up, tested, and operated by the manufacturer to ensure the highest level of quality.

1. To begin working with your Ultima 500, simply open the back door; remove the shipping plugs located on the air inlets of the compressor heads. Store the shipping plugs somewhere secure, just in case you ever need to ship or store your unit without spilling oil from the compressor.

**\*DO NOT RUN THE UNIT WITHOUT REMOVING THE SHIPPING PLUGS\***

Place the air filter housing into the same inlet hole.

2. Uncoil the electrical line and feed it through either one of two round grommets (openings located in the rear of the unit underneath the back door and on the bottom right side of the unit). It is best if you use a dedicated outlet to plug the unit in.

3. Next remove the water bottles and fill them up with distilled water. You also have the option of filling one of the water bottles with an antiseptic solution and the other with just distilled water. *\* If you choose to use an antiseptic solution please make sure to switch over to the bottle with distilled water and run the hand pieces to circulate water through those hand pieces and tubing to avoid any clogs or blockage in the unit and tubing.\**

4. To install handpieces simply mate the rear end of the handpiece with the handpiece tubing connector, then hand tighten the silver Midwest connector.

5. Turn the unit on and begin.

## Table of Contents

1. Control Panel .....	Page 3
2. Hand Pieces .....	Page 4
3. Ultima Silent-Surge Compressor .....	Page 5
4. Ultima Silent-Surge Compressor parts .....	Page 5-6
5. Compressor pump diagram .....	Page 7
6. Compressor frame diagram .....	Page 8
7. Compressor Trouble shooting Guide .....	Page 9
8. General Info/ Trouble Shooting Guide .....	Page 10-16
9. Warranty .....	Page 17

## Control Panel

1. Located on the left side of the front control panel is a small black single screw. When removed this screw will allow the panel to open on its hinge like door; allowing access to the units' panel components.
2. The on/off toggle switch allows you to turn the water on and off to handpieces.
3. The water volume knob is used to increase and decrease the flow of water to the handpieces.
4. The water bottle selector switch is used to switch back and forth between the two (2) water bottles. This is an excellent feature allowing you to fill each bottle with a different solution.

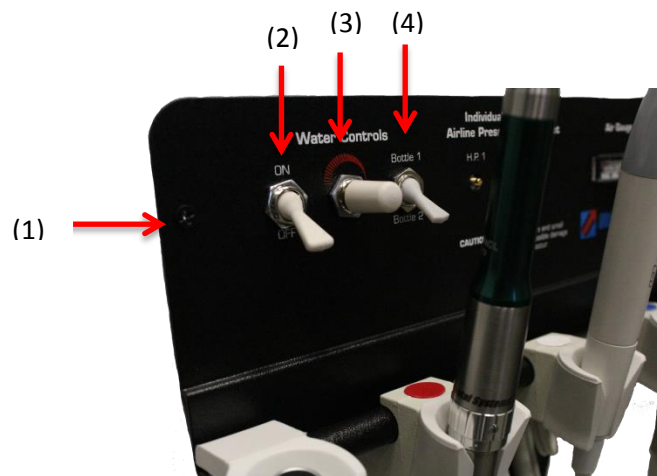

5. The individual handpiece airline pressure adjustment screws are used to make adjustments to and individual handpiece while they are running. The airlines have been preset at the factory.

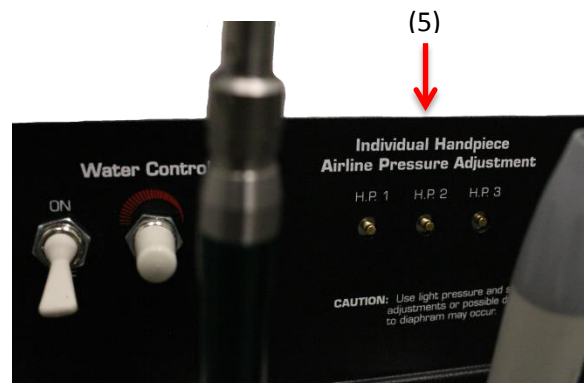

*Continued on Next Page*

6. The rectangular air gauge will show you the pressure of the handpiece that is running while in use.
7. If your unit is equip with a Piezo Scaler on the upper right corner you will find the power dial for the Scaler.

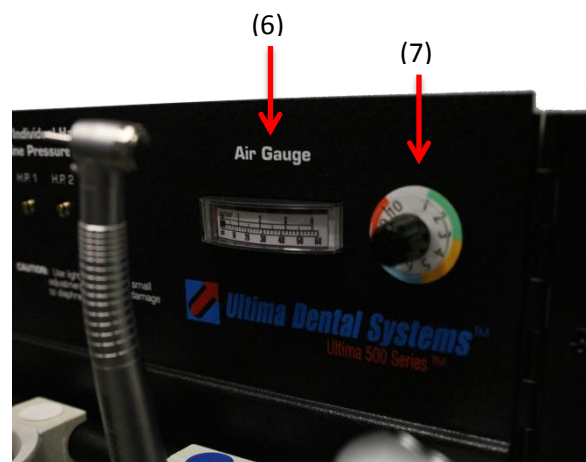

## Handpieces

On the Ultima 500 only one handpiece can be run at a time. They are activated by an automatic holder when removed from its place. The handpiece must be placed in the same holder to deactivate the handpiece in order to allow another handpiece to function. The holders and handpiece tubing has been color coded for your convenience. Red is the low speed handpiece (Polisher), White is the accessories line or Piezo line if the unit is equip with one, and Blue is for the highspeed drill. To run a handpiece simply remove it from the holder and step on the foot control pedal. Handpiece Pressures: HP 1. Red line (Polisher) should be set to 40 – 50 Psi, HP 2. White line is an accessories line and is not set, HP 3. Blue line (High speed drill) should be set to 32 Psi.

*Continued on Next Page*

To install handpieces simply mate the rear end of the handpiece with the hand piece tubing connector.

1. The UDS lowspeed handpiece (Polisher) is and 4:1 E-style handpiece with a 20,000 Rpm motor. Meaning the 4:1 reduction nose cone brings the 20,000 rpm motor down to 5,000 rpm's for polishing. A 1:1 reduction nose cone or contra angle allows you to use the full 20,000 rpm's making it useful on procedures for small animals such as rabbits and other various rodents. This saves time and money because of its 2 in 1 feature.
2. If your unit is equip with a Piezo Scaler built into the middle white accessories line do not worry about the pressure setting for this, as it is an electric Scaler and only uses air to turn a switch on and off.
3. If your unit is equip with a fiber optic high speed drill note that it has an eighteen second delay. This is a great feature; the eighteen second time delay on the handpiece allows you to use the drill as a light wand.
4. If your unit is equip with an LED highspeed drill, there is no time delay. The way the LED light gets powered is by an internal generator that spins when the foot control is pressed to operate the handpiece. Once the foot control is released and the flow of air stopped the light will shut off.
5. The three way syringe is used by depressing the right button for a burst of air, the left button for a stream of water, both buttons depressed will produce a mist.
6. Ultima 500 double compressor units that have the optional suction system can activate it by pushing the silver button on the suction hand piece. The pick-up bottle is located inside the unit behind the water bottle on the right side. To empty the collection bottle simply unscrew and dispose of the waste and reattach the bottle. **IT IS EXTREMELY IMPORTANT NOT TO ALLOW THE COLLECTION BOTTLE TO OVER FLOW!** To clean the suction system, run disinfectant cleaning solution or 10% solution of Clorox through the system.

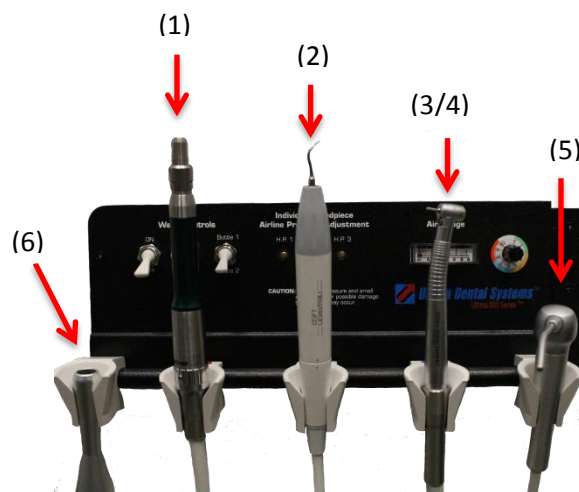

## Ultima Silent-Surge Compressor

1. The air gauge to the left of the Off/Auto switch; the compressor in-line pressure gauge has been preset at the factory to 65-70 Psi. Do Not exceed 70 psi. The air gauge to the right of the Off/Auto switch is the tank pressure gauge. When the compressor on/off switch is set to auto it will build pressure to 120 psi. When the air in the holding tank drops down to 80 psi, the compressor will turn back on and bring the pressure in the holding tank back to 120 psi.

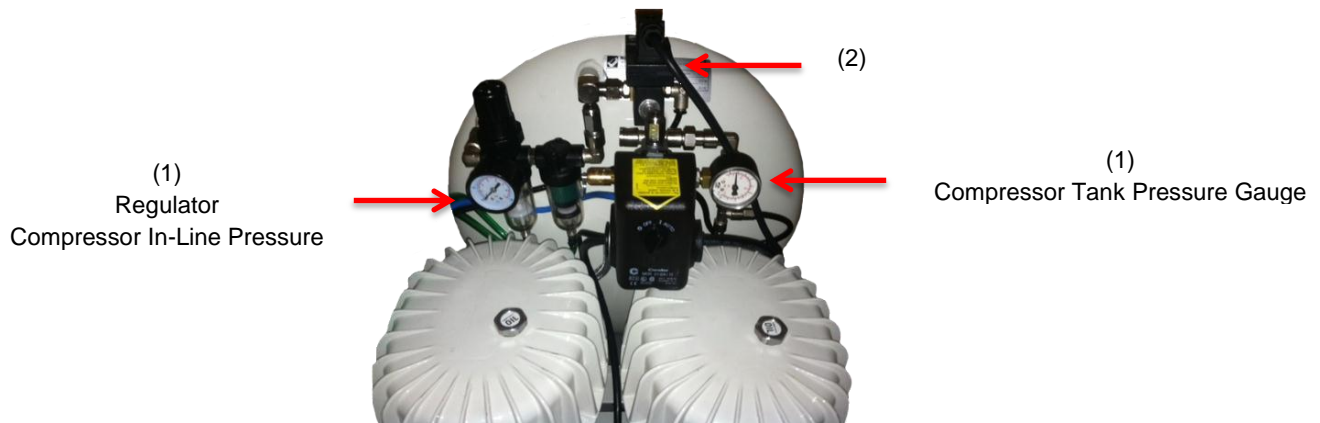

2. The Ultima 500 is equip with an Auto Drain system. The Auto Drain system automatically purges the air holding tank for two seconds for every thrity minutes the power to the unit is on. This feature signifiantly extends the working life of the compressor preventing rust inside the tank.
3. Older Ultima 500 model units have a manual T-shaped valve located on the compressor air tank at about the tweleve o'clock position that must be drained once a week.

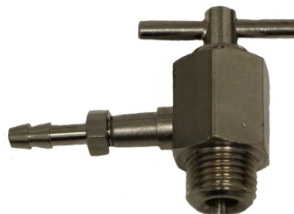

Manual Drain Release Valve

*Continued on Next Page*

4. The compressor pick-up bottle is located on the upper left corner inside the unit. This bottle needs to be emptied and should be checked at least once a week. To empty, just remove the bottle from the bracket, unscrew the bottle, and dispose of the waste.
5. Oil level on the unit should be checked regularly, this should be done before the unit is turned on. The oil should be change once a year.

On the U500 single head pump unit: An access hole is located under the back door where the oil level sight glass is located.

On the U500 Double head pump units: Oil level sight glass for the is located under the shelf on the side of the pumps. Oil level should be  $\frac{1}{2}$  to  $\frac{2}{3}$  full.

The compressor pumps can be found underneath the white U-shaped shelf inside the unit.

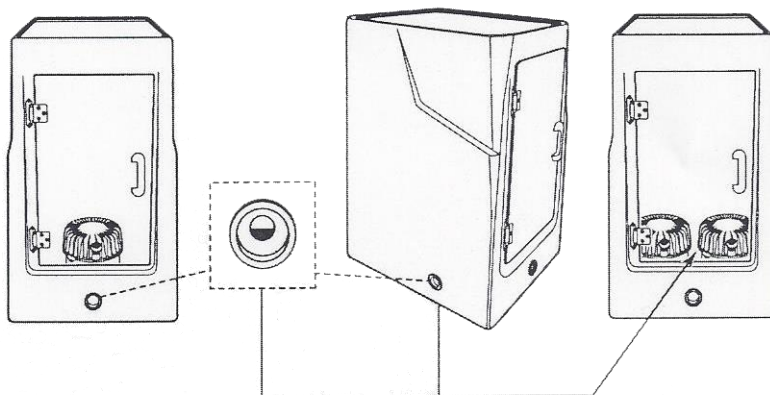

For Silent-Surge Oil or Ultima Re-Charge kit Call Ultima Dental Systems at (954) 772-9779 or your local distributor.

The Ultima Re-charge kit includes: Two bottles 24oz bottles of Silent-Surge compressor oil, heavy duty pump to remove oil, and four replacement air filter elements – Part# UD-2219



Re-Charge Kit



24oz Bottle Of Syntentic Silent Surge Compressor Oil  
Part # UD-OIL



## Compressor Parts List

### Ultima Compressor Regulator Parts

Part #	Description
UD-C0164-N7	Comp. Coalescent Filter w/ Plastic Housing O-Ring
UD-C0164-N3	Comp. Regulator Filter Set Up (Half – No metal barb)
UD-C0164-NCOMBO	Complete Comp. Regulator Set Up w/ Filters
UD-C0164-N1	Comp. Regulator w/ Knob & Coalescent Filter Set Up (Half)
UD-C0164-N6	Comp. Regulator Filter w/ Plastic Housing O-Ring
UD-C0164-N5-1	Comp. Regulator Filter Plastic Housing
UD-C088-WI	Comp. Regulator Pressure Gauge
UD-C0239-WI	Comp. Regulator Plastic Bottle metal barb

### Ultima Compressor Pump Parts

Part #	Description
UD-C0358-WI	Comp. Oil Level Indicator
UD-2219	Comp. Oil Re-charge kit
UD-OIL	Ultima Silent Surge Comp. Oil (24oz Bottle)
UD-JA34060-DEP	Ultima Comp. Oil Removal Pump
UD-C1235-WI	Comp. Valve Plate w/ Gasket
UD-C9993-WI	Comp. Upgrade Kit (Single Pump Only)
UD-C0303-WI	Comp. Dome O-Ring
UD-C0011-1	Comp. Air Filter Elements (4 pack)
UD-C1794-WI	Comp. Air Intake Filter Housing
UD-C059-WI	Comp. 1/8" Female Hose Barb
UD-C0338-WI	Comp. Capacitor 115 Volt
UD-C0317-WI	Comp. Overload Protector
UD-C0325-WI	Comp. Starting Relay 115 Volt

## Ultima Compressor Pressure Switch Parts

Part #	Description
UD-C0340-WI	Comp. Pressure Switch 4-P
UD-C0340-1- WI	Comp. Pressure Switch Cover
UD-C0124-WI	Comp. Safety Valve
UD-C0202-WI	Comp Unloader Valve

## Ultima Compressor Misc. Parts

Part #	Description
UD-SE-45117-WI	Comp. Pick Up Bottle Clip
UD-1260-WI	Comp. Pick Up Bottle Only
UD-C1260-1-WI	Comp Pick Up Bottle w/ Tubing
UD-C0351-WI	Comp. Check Valve
UD-C0354-WI	Comp. Drain Release Valve
UD-C0933-WI	Comp Fan 120 Volt
UD-C0664-WI	Comp. Fan Cover
UD-C0026-WI	Comp. Tank Pressure Gauge

## Compressor Pump Diagram

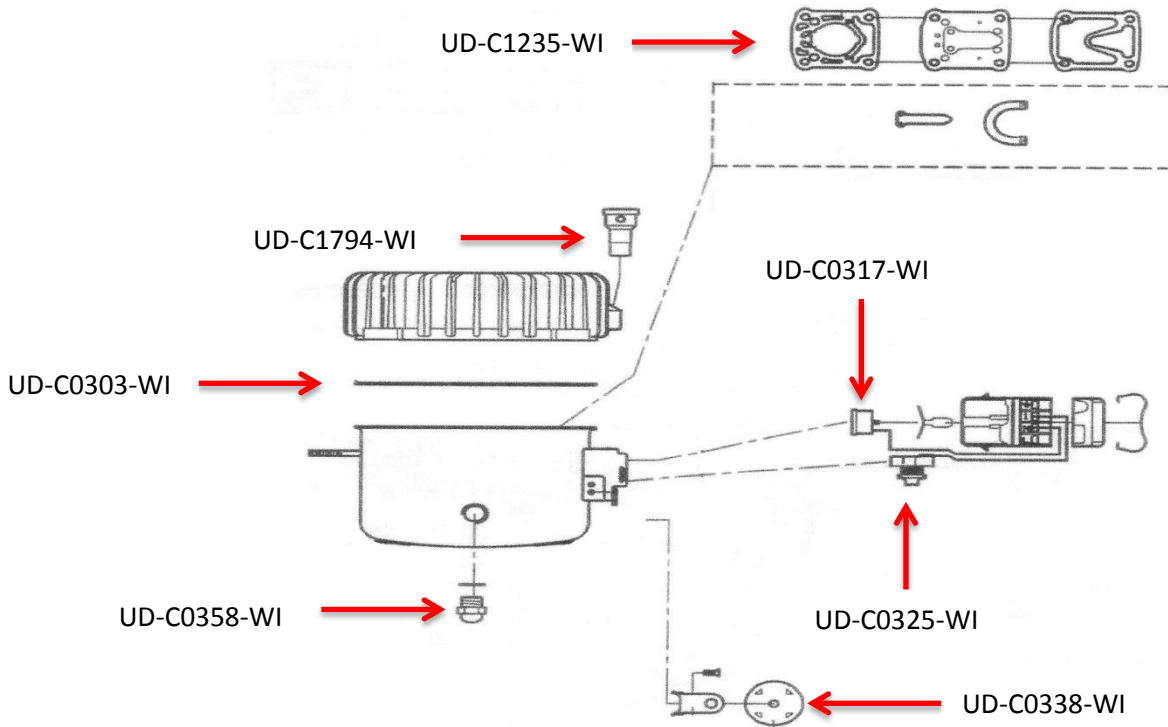

# Compressor Frame Diagram

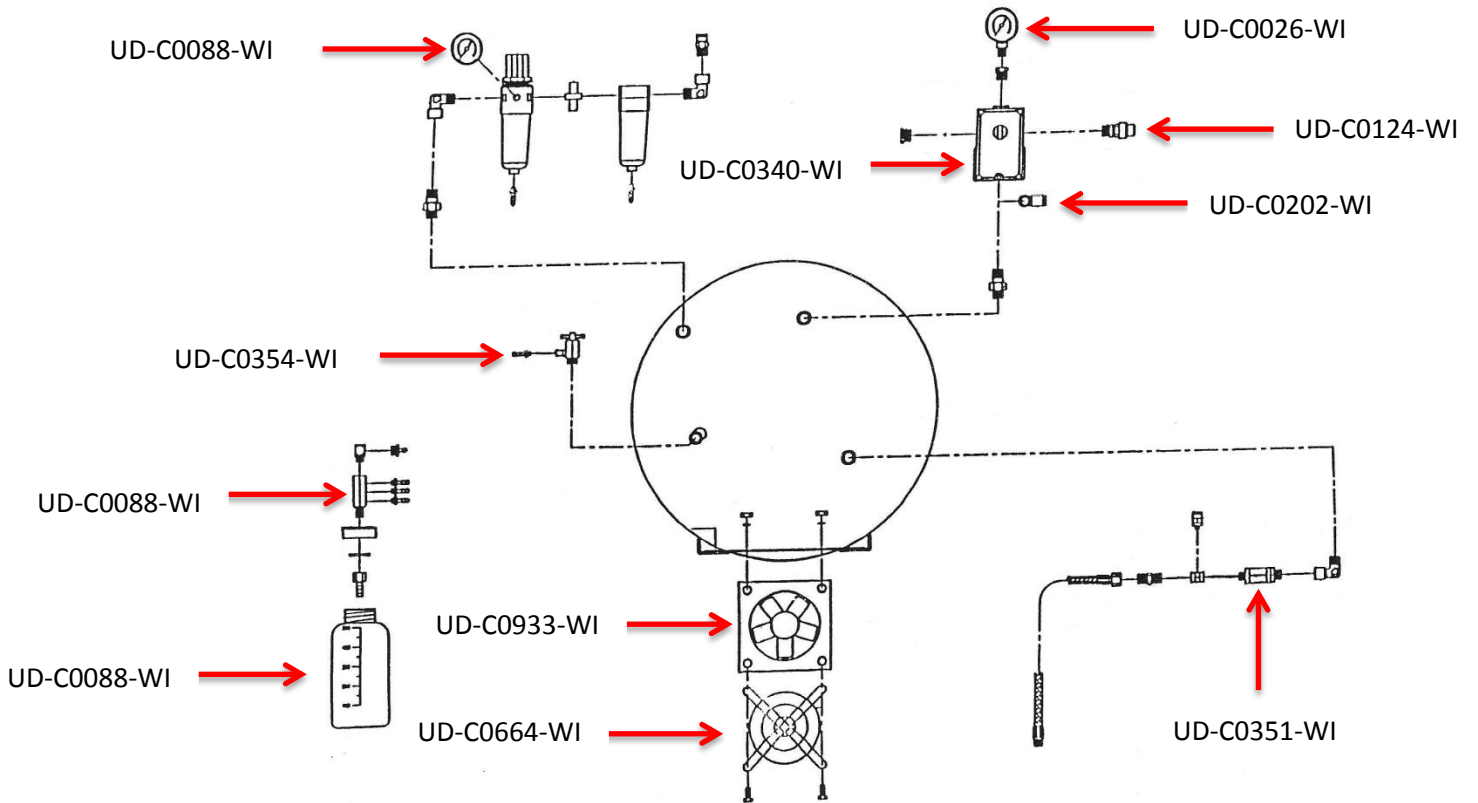

**HELPFUL HINTS**

- 1) Carefully inspect the hoses, fittings and overall appearance before each use.
- 2) Always operate the compressor on a flat surface.
- 3) Periodically check the oil level and top off to mid-level.
- 4) Use only properly grounded outlet that will accept 3-pronged plugs. Do not operate the compressor with a damaged cord.
- 5) Keep the compressor free of dust, dirt and paint. This will prolong Air Intake Filter operation and prevent clogging of Safety Relief Valve.
- 6) Use only recommended handling tools and attachments that are acceptable for pressure rated for this compressor.
- 7) Adjust the pressure regulator according to the recommended pressure setting of the air tool before attaching the tool to the compressor. When disconnecting attachments, close the pressure regulator counterclockwise, or bleed off all pressure from the tank and system.
- 8) Do not substitute or mix the oil in your compressor with other available brands. Any attempt to use oil different from that specified by the manufacturer will result in compressor breakdown and void all warranties.
- 9) Do not direct the air stream at your body.
- 10) To reduce the risk of **ELECTRIC SHOCK**, do not expose the unit to rain or water while in use.
- 11) Never attempt to service the compressor while it is plugged into an electrical outlet.
- 12) Avoid direct contact with the surface while operating – high temperatures may be present.
- 13) Use only factory authorized parts.
- 14) Always store your compressor in a clean and dry environment when in use. Make sure all air pressure has been released from the system.



**Warning:** Any attempt to service your compressor by removing the compressor shell or terminal box cover, tampering with the pressure switch setting and/or grounding plug will void the limited warranty and may make the compressor unsafe to use.

TROUBLE	CAUSE	REMEDY
Compressor will not run	No Power	Check outlet voltage, fuse and circuit breakers
	Bad cord connection for incorrect extension cord	Check cord connection for visible damage- if using an extension cord, make sure it is UL approved, and it's heavy duty and grounded
	Holding tank is fully pressurized	Use your equipment to lower pressure in tank
Compressor runs but will not supply air	Thermal overload protection has tripped	Wait 15 minutes and try starting again – if this was the cause; make sure compressor is in well ventilated area: check installation leaks; set the regulator's pressure minimum required for your equipment
	Air pressure regulator not set properly	Reset Air-Regulator to pressure required by your equipment
	Air-Intake Filter clogged or not installed	Clean Air-Intake Filter or replace
Rattling noise during operation	Extensive leak	Install Air-Intake Filter on suction tube or hole (see machine set-up); check all fittings, connections and equipment, close your pressure regulator all the way (counterclockwise) – if pressure in tank builds up, leak is in your installation
Milky oil in compressor	Compressor motor touching shell	Operate on level surface – check oil level and adjust if it's necessary
Air-Tank not holding pressure when compressor is not running	Oil has been contaminated with moisture or other foreign matter	Change oil – Oil needs to be changed every 150 hours; use only original oil from <b>Werther International, Inc.</b>
No air pressure shown on regulator gauge	Faulty Check Valve Defective/Cracked Manifold See "Air Leak"	Disconnect pressure hose at pump and check for leaking back into pump – Clean or replace the check valve – Spray all connections and manifold with soap solution and reseal or replace leaking parts Call Werther 800-972-7668 for assistance.
	No equipment connected to compressor	Connect equipment
	Regulator has not been adjusted	Lift knob and turn clockwise until gauge shows required pressure – Gauge should be set at minimum level required by your equipment

## **Piezo Scaler Quick Reference Guide**

### ***Magnetostrictive***

---

Developed In the 1950's, Magnetostrictive units (cavitron style) vibrate a tip (insert) at either 25k or 35k (cps). The handpiece of a magnetostrictive ultrasonic is hard wired into the ultrasonic unit, therefore it is not detachable nor autoclavable.

The tip is attached to several long metallic stacks. These stacks are inserted into the handpiece. Under the handpiece and surrounding the metal stacks are several coiled wires which when excited by electricity give a vibration to the insert's stacked metal plates caused by a "magnetic field" which is produced. The tip of the insert vibrates in an elliptical motion.

The handpiece generates a tremendous amount of heat, which requires a high volume of water to constantly run through the hand piece to keep it cool. This excessive amount of water causes the practitioner poor visibility. IT BASICALLY WORKS LIKE A JACK-HAMMER.

### ***Piezo Electric***

---

Piezo was first developed in 1972 by SATELEC. The handpieces are detachable and autoclavable. Inside the hand piece is the "transducer". The transducer consists of ceramic disks stacked next to one another. These ceramic disks have high quartz content and when excited with electricity they compress and decompress causing a controlled vibration, the result is an ultrasonic vibration in a linear motion (forward and backward) on the same plane as the handpiece.

There is very little to no heat generated in the handpiece requiring a minimal amount of water, which means better visibility for the practitioner and a dryer patient. The water from the tip flushes removed deposits and is required for " the cavitation effect" to de-bridge bio-film.

The linear tip motion is also more efficient and more comfortable. When the magnetostrictive tip vibrates, it bangs on the surface of the tooth to knock calculus off in chunks, where as a piezo tip vibrates linearly so the tip works along the tooth surface, shaving calculus off in sheets. Satelec piezo ultrasonic scalers also leaves the tooth surface smoother than other ultrasonic scalers, sonic scaler, and hand instrumentation.



Potentiometer Faceplate

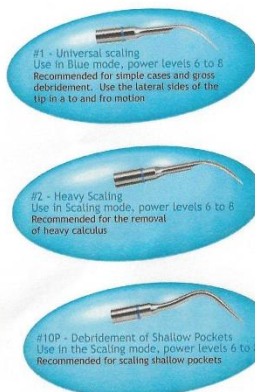

## Tips On Your First Piezo Experience

Most likely, you are coming from years of working with a Cavitron or similar magnetorestrictive type unit. You are in for a very pleasant surprise...

### Water Flow -

Cavitron users are accustomed to heavy water spray. With Piezo, the handpiece doesn't heat up (only the tip requires cooling) so water spray is reduced tremendously:

- Insert Tip #1 (universal supra-gingival scaling tip) into the handpiece.
- Turn the power control down to its lowest setting.
- Taking the water from the off position, start to "inch" it up a bit until you get a drop rate of about 2 - 3 drops of water per second.
- Turn the power of the unit up to its intended operating range (Blue Mode)

You will be pleasantly surprised to find that 2-3 drops of water is a very fine mist creating a "halo" effect around the tip providing improved visibility and increased patient comfort.

### Technique -

Cavitron users are accustomed to utilizing magnetorestrictive tips differently from the way a SATELEC tip should be used. With the elliptical motion a Cavitron provides, you are accustomed to using the front, side or back of the tip to bang the tooth to remove calculus. This often causes patient discomfort and can embed calculus into the surface of the root preventing reattachment. With Piezo the process is different:

- The tip vibrates on the same plane as the handpiece. The tip moves forward and back, making the lateral sides of the tip extremely efficient for shaving the calculus.
- This stroke is a mirror image of hand instrumentation (with extraordinary results achieved), requiring only very little pressure resulting in no hand fatigue.
- The easiest way for you to understand the concept is for you to try to scale without activating the foot control. Most likely, you will automatically scale with the side of the tip. The H3 (which is in the Intro Scaling Kit) is a wonderful tip for conveying this concept since it looks like a hand instrument curette.



Standard Satelec HP



LED Satelec HP

<u>Fault Detected</u>	<u>Possible Causes</u>	<u>Solutions</u>
<b>Handpiece does not vibrate</b>	<ol style="list-style-type: none"> <li>1. Faulty handpiece cord &amp; connector</li> <li>2. Scaler cord wire cut</li> <li>3. Hand piece damaged</li> <li>4. Electrical contacts on cord are loose</li> <li>5. Tip worn or distorted</li> </ol>	<ol style="list-style-type: none"> <li>1. Replace the handpiece cord &amp; connector</li> <li>2. Replace tip</li> <li>3. Replace handpiece</li> <li>4. Contact Pro Service repair 1(800) 645-6594 to schedule on site visit</li> <li>5. Contact the UDS Technical support team for further assistance (954) 772-9779</li> </ol>
<b>Weak Vibration</b>	<ol style="list-style-type: none"> <li>1. Tip worn or distorted</li> <li>2. Tip over tighten</li> <li>3. Incorrect use</li> <li>4. Fluid or Moisture in handpiece or cord &amp; connector</li> </ol>	<ol style="list-style-type: none"> <li>1. Replace the tip/Check tip chart to see if worn</li> <li>2. Tighten the tip using the tip wrench</li> <li>3. Dry electrical contacts</li> </ol>
<b>Fluid leakage between hand piece and cord</b>	<ol style="list-style-type: none"> <li>1. Worn hand piece seal</li> </ol>	<ol style="list-style-type: none"> <li>1. Replace the seal</li> </ol>
<b>No light (L.E.D model only)</b>	<ol style="list-style-type: none"> <li>1. Faulty L.E.D ring</li> <li>2. Faulty hand piece / cord connector contacts</li> </ol>	<ol style="list-style-type: none"> <li>1. Clean the L.E.D ring contacts/ Replace L.E.D ring</li> <li>2. Clean the hand piece / cord connector contacts</li> <li>3. For further assistance call the UDS Technical support team: (954) 772-9779</li> </ol>





Serving the Veterinary Industry Since 1984

## **Trouble shooting Guide**

### ***No water***

---

1. Check the water on/off toggle switch and make sure it is in the on position.
2. Check the water increase/decrease knob and make sure it is turned up.
3. Grab the three way syringe and check to see if you get water from the hand piece.
4. Inspect the water bottles. Check for air leaks around the water bottles, make sure their secured tightly to the pressure head.
5. Squeeze the bottles to check the pressure; the bottles should be rock hard.

If no water continues to be the issue, the problem may be more involved and may require a professional Dental equipment technician.

Other causes of no water issues could involve the blockage, failure, or damage of the water relay, control block, control block diaphragm, and the distribution block.

To determine the exact cause of the issue and to schedule an in office visit by a certified technician Call Pro Repair Service: 1-800-645-6594. For all other general questions contact the UDS Technical Support team: (954) 772-9779.

Please check with the local Dental Repair Service or Equipment distributor in your area if you wish to schedule an in office visit outside of the U.S.A.

## Trouble shooting Guide

### *Polisher*

---

1. When stepping on the foot control, motor runs, but prophy angle does not spin.\*Check the gear dial on the bottom of the polisher below the Ultima Dental Systems logo and just above the Midwest connector. The three lines are the gears, the left line is reverse, the middle line is neutral, and the right line is forward.

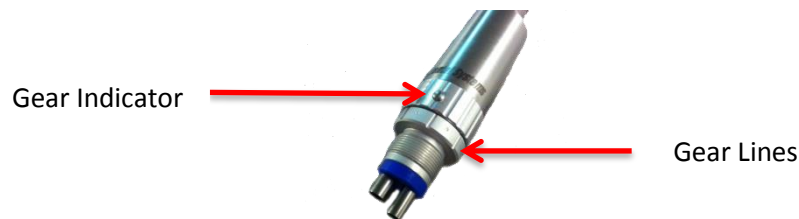

2. Motor runs, but prophy cup does not spin.  
\*Turn the collar clockwise to lock down the prophy angle, make sure the prophy angle is tightly secure.

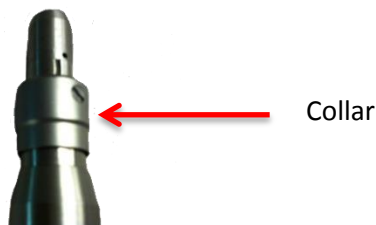

### ***Polisher Continued***

---

1. Motor does not run

\* Oil the polisher to ensure the inside components are lubricated. To oil the polisher disconnect the handpiece from the tubing, you will notice four metal barbs on the bottom of the polisher – two small barbs and two big one's - place two to three drops of hand piece oil into the smaller of the two larger barbs.



Re-connect the hand piece and run it upside down for thirty seconds to allow the oil to travel through the polisher. It is important that the polisher be run upside to avoid the thin hand piece oil from slide back down the hand piece tubing.

2. The whole nose cone spins regardless of whether or not the collar is locked or unlocked.\* If the whole nose cone spins with the collar locked or unlocked, the nose cone shaft is damaged and needs to be replaced. Part# UD-GNC For the 4:1 reduction green nose cone and UD-BLNC For the 1:1 reduction Blue nose cone.
3. .\*Polar pressure should be between 40-50 Psi. Adjust gold screw the reads HP 1 on the front panel if needed. When adjusting the pressure turn the screw slowly to avoid damaging the control block diaphragm.

For question regarding repairs or replacement parts contact your local distributor or call UDS Technical Support: (954) 772-9779.

## Trouble Shooting Guide

### High Speed Drill

---

1. The drill will not spin when stepping on the foot control.

\*First disconnect the hand piece from the tubing. Step on the foot control to see if you get air coming from the tubing, if so the problem is with the hand piece.

\*Next, spin the bur with your fingers, the bur should spin freely. If this is not the case, oil the hand piece to make sure the turbine is lubricated. To oil the drill simply turn it upside down. On the bottom of the drill there are four metal barbs, two small barbs and two big ones. Add two to three drops of hand piece oil to the smaller of the two larger barbs located on the bottom of the drill. Re-attach the hand piece and run the drill upside down for thirty second to a minute to allow the oil to circulate through the drill.

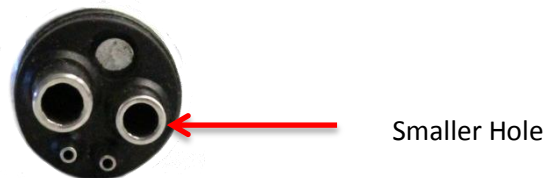

\*If this does not solve the issue of the drill not spinning, a new turbine may be required. For a push button drill use part # UD-TBAKSPB. For a standard non push button drill use part # UD-TBAKSSD-MD



Standard Turbine



Push Button Turbine

For question regarding repairs or replacement parts contact your local distributor or call UDS Technical Support: (954) 772-9779.

# Trouble Shooting Guide

## High Speed Drill

---

1. If the bur (drill bit) is stuck inside the drill and will not come out.

\*The turbine inside the drill is most likely damaged and needs to be replaced. To double check the turbine, un-screw and remove the end cap located on the back of the drill head



Push Button Turbine

Check for debris, this is a sign that parts inside the turbine may have come loose. Remove the turbine and try to manual remove the bur, if the bur is lodged in there and can't be removed replace the turbine. For a push button drill use part # UD-TBAKSPB For a standard non push button drill use part # UD-TBAKSSD-MD

1. You feel air coming from the bottom of the hand piece.

\*Disconnect the hand piece and inspect the gasket on the bottom of the handpiece for any damage.

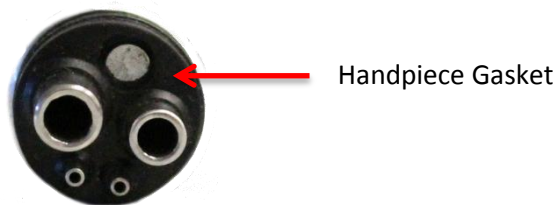

The high Speed Drill pressure should be set to 32 Psi.\* Adjust gold screw the reads HP 3 on the front panel if needed. When adjusting the pressure turn the screw slowly to avoid damaging the control block diaphragm.

For question regarding repairs or replacement parts contact your local distributor or call UDS Technical Support: (954) 772-9779