

2014  
Animal Health

MATRIX® ANESTHESIA  
SERVICE PARTS GUIDE







## Practice With Confidence.

When you partner with Midmark, you can rest assured that you are using the best. The Midmark family of veterinary products represents an unswerving commitment to quality and value backed by over 90 years of healthcare manufacturing and clinical use experience.

### Midmark Customer Service

Midmark Customer Service personnel are available to serve your needs from 8:00 AM - 5:00 PM, Monday through Friday, EST.

1-800-MIDMARK  
Fax: 1-877-725-6495

For equipment information or order placement contact Customer Service at 1-800-MIDMARK, press 8, then 8951.

### Midmark Technical Service

Midmark Technical Service personnel are available to serve your needs from 8:00 AM - 5:00 PM Monday through Friday, EST. 1-800-MIDMARK, press 8, then 8020.

### Service and Repair

Contact Technical Service at 1-800-MIDMARK or fax your service parts or repair orders to 1-877-725-6495.

---

### Table of Contents

Absorbers, VMS <sup>®</sup> , VMC <sup>®</sup>	8
Flowmeters	2, 3
Inhalation/Exhalation Valves	4
VMC <sup>®</sup>	7
VME <sup>®</sup>	10
VME2 <sup>®</sup>	9
VME <sup>®</sup> Tabletop	11
VML <sup>®</sup>	12
VMS <sup>®</sup>	6
VMS <sup>®</sup> Plus	5

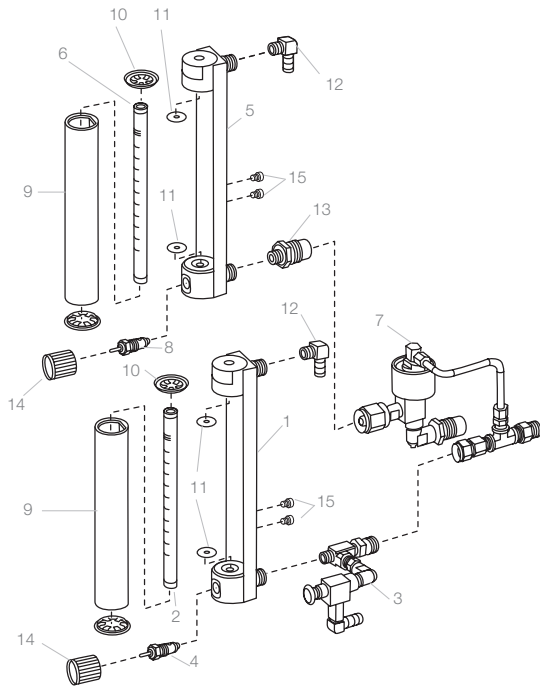

## Matrix VML® Flowmeter Assemblies

### Matrix VML® O<sub>2</sub> Flowmeter Assembly without Flush

1	91805082	(USA)
	91805066	(ISO/Canadian)

### Matrix VML O<sub>2</sub> Flowmeter Tube Only

2	91800642	.5 - 10 lpm
---	----------	-------------

### Matrix VML O<sub>2</sub> Flush Valve Assembly

3	92305375	(USA/ISO/Canadian)
---	----------	--------------------

### Replacement O<sub>2</sub> Needle Valve with Positive Stop

4	91800655	Knob Sold Separately, see item #14, right
---	----------	---

### Matrix VML N<sub>2</sub>O Flowmeter Assembly without Fail-safe

5	91805085	(USA)
	91805072	(ISO/Canadian)

### Matrix VML N<sub>2</sub>O Flowmeter Tube Only

6	91800645	
---	----------	--

### N<sub>2</sub>O Fail-safe Assembly

7	n/a	Not Available
---	-----	---------------

### Replacement N<sub>2</sub>O Needle Valve Assembly with Positive Stop

8	91800655	Knob Sold Separately, see item #14, right
9	91805600	Replacement Lens
10	91805400	Replacement End Caps .5 - 10 lpm
11	91800269	Replacement Gaskets .5 - 10 lpm
12	91800271	Repl. 90° Elbow, 1/4M Hose Barb x 1/8" NPT.
13	91800272	Repl. N <sub>2</sub> O DISS Fitting.
n/s	10555200	Screw kit for Matrix VML #10-32 x 3/8

## Matrix VMS®/VMS® Plus/ VME®/VME2®/VMR® Flowmeter Assemblies

### Matrix VMS®/VMS® Plus/VME®/VME2®/VMR® O<sub>2</sub>

#### Flowmeter Assembly without Flush

1	91805081	(USA)
	91805064	(ISO/Canadian)
	91805083	(USA) (0 - 1000cc)
	91805068	(ISO/Canadian) (0 - 1000cc)

### Matrix VMS/VMS Plus/VME/VME2/VMR O<sub>2</sub> Flowmeter Tube Only

2	91800641	.2 - 4 lpm
	91800643	0 - 1000cc

### Matrix VMS O<sub>2</sub> Flush Assembly

3	92305375	(USA/ISO/Canadian)
	61900300	Push Button

### Matrix VMS Plus/VME2 O<sub>2</sub> Flush Valve Assembly

3	92305398	(USA/ISO/Canadian)
---	----------	--------------------

### Replacement O<sub>2</sub> Needle Valve Assembly with Positive Stop

4	91800655	Knob Sold Separately, see item #14
---	----------	------------------------------------

### Matrix VMS/VMS Plus/VME2 N<sub>2</sub>O Flowmeter Assembly without Fail-safe

5	91805084	(USA)
	91805070	(ISO/Canadian)
	91805086	(USA) (0 - 1000cc)
	91805074	(ISO/Canadian) (0 - 1000cc)

### Matrix VMS/VMS Plus/VME2 N<sub>2</sub>O Flowmeter Tube Only

6	91800644	.2 - 4 lpm
	91800646	0 - 1000cc

### N<sub>2</sub>O Fail-safe Assembly

7	n/a	Not Available
---	-----	---------------

### Replacement N<sub>2</sub>O Needle Valve Assembly with Positive Stop

8	91800655	Knob Sold Separately, see item #14
9	91805600	Replacement Lens
10	91805300	Replacement End Caps .2 - 4 lpm
	91805500	Replacement End Caps 0 - 1000cc
11	91800268	Replacement Gaskets .2 - 4 lpm
	91800270	Replacement Gaskets 0 - 1000cc
12	91800271	Repl. 90° Elbow, 1/4M Hose Barb x 1/8" NPT
13	91800272	Repl. N <sub>2</sub> O DISS Fitting.

### Replacement Needle Valve Knobs

14	91800702	Green
	91800704	Blue
	91800703	White
15	10503100	Screw kit for Matrix VMS Plus flowmeter #10-32 x 1/4
	10503200	Screw kit for Matrix VMS, VME and VMR #10-32 x 5/16

## Matrx VMS®/VMS® Plus/VME® Flowmeter Assemblies

### Matrx VMS®/VMS® Plus/VME® O<sub>2</sub> Flowmeter Tube Only

1	63902902	(USA)
	91805039	(ISO/Canadian/Swedish)
	62966000	(USA/ISO/Canadian/Swedish) (0-1000cc)

### Matrx VMS O<sub>2</sub> Flush Valve Assembly

2	92305375	(USA/ISO/Canadian)
---	----------	--------------------

### Matrx VMS Plus O<sub>2</sub> Flush Valve Assembly

2	92305398	(USA/ISO/Canadian)
---	----------	--------------------

### Replacement O<sub>2</sub> Needle Valve Assembly with Positive Stop

3	63300512	(USA)
	63300701	(ISO/Canadian/Swedish)

### Matrx VMS/VMS Plus N<sub>2</sub>O Flowmeter Tube Only

4	63902901	(USA)
	91805034	(ISO/Canadian/Swedish)

### N<sub>2</sub>O Fail-Safe Assembly

5	n/a	Not Available
---	-----	---------------

### Replacement N<sub>2</sub>O Needle Valve Assembly with Positive Stop

6	63300513	(USA)
	63300703	(ISO/Canadian/Swedish)
7	92815409	Plastic Cover
8	62917008	90° Elbow, 1/4M Hose Barb x 1/8" NPT.
9	91805042	Inlet/Outlet Adapter NPT x 1/4.
n/s	10503200	Screw kit for Matrx VMS, VME and VMR™ #10-32 x 5/16

### Replacement Needle Valve Knobs

10	65927101	Green
	65927102	Blue
	65927103	White

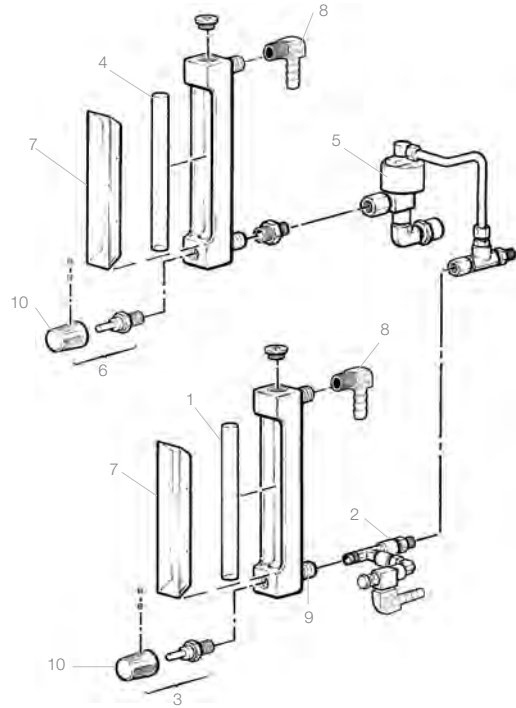

## Matrx VML® Flowmeter Assemblies

### Matrx VML O<sub>2</sub> Flowmeter Tube Only

1	63902802	(USA)
	91805040	(ISO/Canadian/Swedish)

### Matrx VML O<sub>2</sub> Flush Valve Assembly

2	92305375	(USA/ISO/Canadian/German/Swiss)
---	----------	---------------------------------

### Replacement O<sub>2</sub> Needle Valve Assembly with Positive Stop

3	63300512	(USA)
	63300701	(ISO/Canadian/Swedish)

### Matrx VML N<sub>2</sub>O Flowmeter Tube Only

4	63902801	(USA)
	91805035	(ISO/Canadian/Swedish)

### N<sub>2</sub>O Fail-safe Assembly

5	n/a	Not Available
---	-----	---------------

### Replacement N<sub>2</sub>O Needle Valve Assembly with Positive Stop

6	63300513	(USA)
	63300703	(ISO/Canadian/Swedish)
7	92815409	Plastic Cover
8	62917008	90° Elbow, 1/4M Hose Barb x 1/8" NPT
9	91805042	Inlet/Outlet Adapter NPT x 1/4
n/s	10555200	Screw kit for Matrx VML #10-32 x 3/8

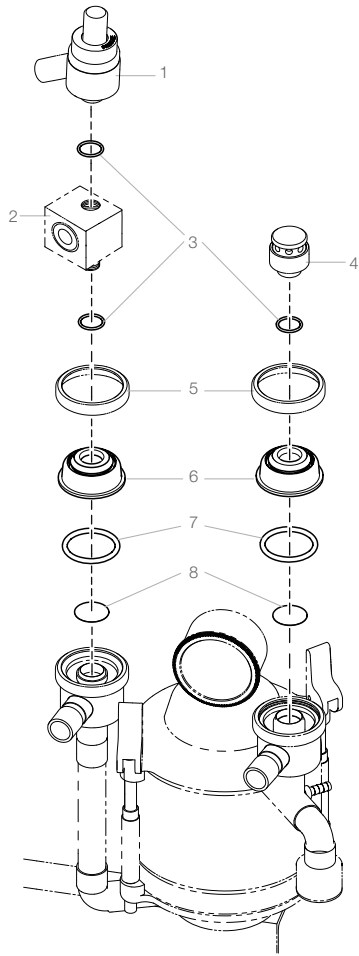

Matrix VMS/VMS Plus/VMC Inh/Exh Valve Parts

## Inhalation/Exhalation Valves

### Matrix VMS®/VMS® Plus/VMC® Inhalation/Exhalation Valve Parts

1	002-1702-00	APL Valve
2	93805114	Occlusion Valve (VMS and VMS Plus Only)
3	63200145	O-Ring
4	92805012	Air Intake Valve
5	10010500	Dome Retainer Ring
6	92805015	Plastic Dome
7	63200113	O-Ring
8	10049000	White Nylon Valve Disc

### Matrix VML® Inhalation/Exhalation Valve Parts

8A	20004500	Dome Retainer Ring
9	20048200	Plastic Dome Assembly
10	61200700	Gasket
11	10006600	Nylon Disc
12	10006400	Dome Pin
n/s	63200124	Lower O-Ring (2-153)
n/s	62500121	Pan Head Screw – 10-32 x 1/2 for mounting valve to VML

### Matrix VME2®/VME® Tabletop Inhalation/Exhalation Valve Parts

13	65927800	Thumbscrew
14	10391800	Dome Clamp
15	10010200	Dome, Inhalation VME Tabletop
16	92805015	Dome, Exhalation VME Tabletop
17	63200113	O-Ring
18	10049000	White Nylon Valve Disc
19	002-1702-00	APL Valve

### Matrix VML Tie Rod Assembly

1A	61920700	Knob
2A	61600200	White Nylon Washer
3A	20047400	Tie Rod

### Matrix VML APL Valve Assembly

4A	002-1702-00	APL Valve
5A	63200145	O-Ring
6A	20113500	APL Valve Adapter

### NOTE:

Part number 63200145 is included with APL Valve and Air Intake Valve but can be ordered separately.

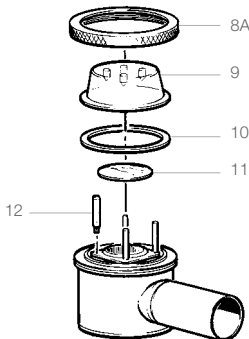

Matrix VML  
Tie-Rod Assy.

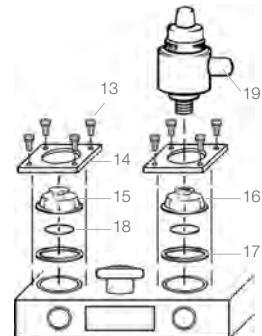
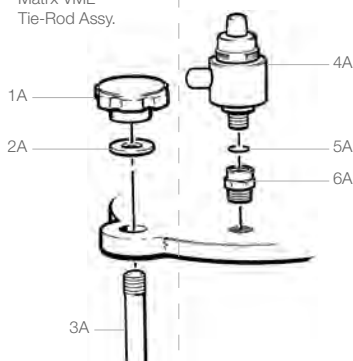

Matrix VME2®/VME® Tabletop Inhalation/  
Exhalation Valve Parts

# Matrix VMS® Plus

- |     |                 |   |
|-----|-----------------|---|
| n/s | 91303015        | Maintenance Kit for Matrix VMS®, VMS® Plus, VMC®  |
| 1   | 91800039        | VMS Absorber Assembly   |
|     | 029-5151-02     | a) VMS units with a "V" serial number prefix<br>b) VMS units without a "V" serial number prefix |
| 2   | 91315075        | Black Neoprene Rubber Tubing, 1/4" ID.<br>(specify length in inches when ordering)              |
| 3   | 10503100        | Screw Kit (10-32 x 5/6")  |
| 4   | 61911000        | "Y" Connector   |
| 5   | 62600204        | Lock Washer   |
| 6   | 62700112        | Bolt  |
| 7   | 65928400        | Caster  |
| 8   | 61902403        | Spider Base, 5-Leg  |
| 9   | 65929300        | Column  |
| 10  | 61402002        | Wing Nut  |
| 11  | 92305073        | FS-2 Outlet Adapter   |
| 12  | 92305072        | FS-2A Inlet Adapter   |
| 13  | 91800203        | O <sub>2</sub> Flowmeter with Flush Assy.   |
| 14  | 050-8688-00-216 | Shelf   |
| n/s | 91316042        | 2 Liter Breathing Bag   |
| n/s | 91316420        | Breathing Circuit, 22mm Dia.  |
| n/s | 91316419        | Breathing Circuit, 15mm Dia.<br>w/1 Liter Breathing Bag   |



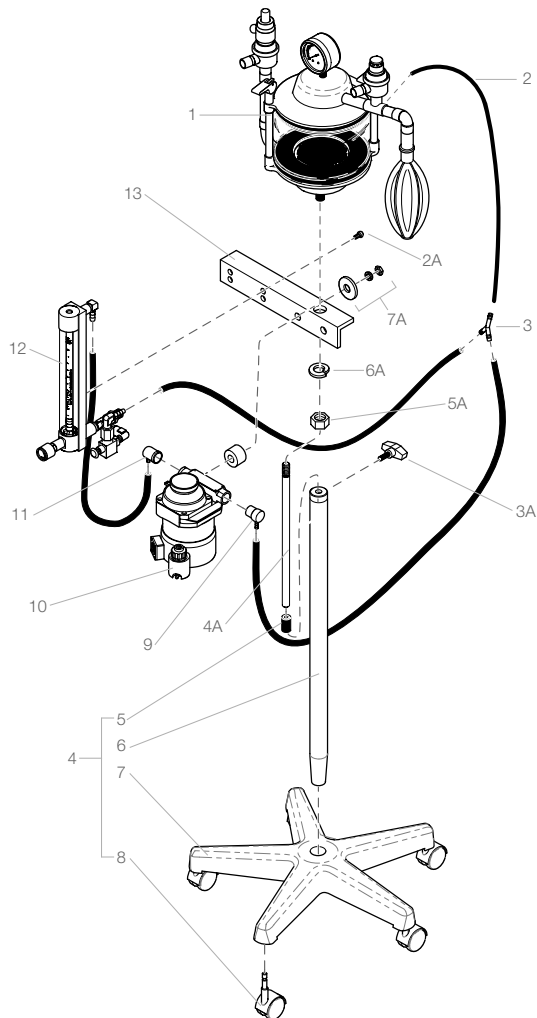

## Matrix VMS®

n/s	91303015	Maintenance Kit for Matrix VMS®, VMS® Plus, VMC®
1	91800039	VMS Absorber Assembly
	029-5151-02	a) VMS units with a "V" serial number prefix b) VMS units without a "V" serial number prefix
2	91315075	Black Neoprene Rubber Tubing, 1/4" ID (specify length in inches when ordering)
3	61911000	Nylon "Y" Connector
4	91806046	VMS 40" Stand Assembly includes items 5-8, 3A-6A
5	91305280	Post Mount Spacer
6	20122401	Column
7	61902403	Spider Base, 5 leg
8	65928400	3" Caster
9	92305073	FS-2 Outlet Adapter
10		Vaporizer
11	92305072	FS-2A Inlet Adapter
12	91800206	O <sub>2</sub> Flowmeter with Flush Assy
13	050-8413-00-312	Mounting Bracket

### Detail A (rear view)

1A	91525269	Optional Drain Valve Assembly
2A	10503200	Screw kit for Matrix VMS, VME® and VMR #10-32 x 5/16
3A	65936800	Tee Handle-Stand
4A	92505017	15" Mounting Stud
5A	62400318	Hex Nut 5/8"-18
6A	62600204	5/8" Lock Washer
7A	91305093	Vaporizer Mounting Kit for Matrix VMS, VMC and VML®
n/s	91525270	Replacement Pipe Plug Assembly

For Matrix VMS inhalation/exhalation valve parts, see page 4.  
For Matrix VMS nitrous oxide/oxygen flowmeter assemblies and parts, see pages 2 and 3.

## Absorber Quick Release Conversion Kit

Easily convert a thumb nut version absorber to a convenient quick release absorber. Simple flip lever locking mechanism allows you to easily seal the absorber canister. Compatible with anesthesia machines manufactured by Fraser Harlake, Ohmeda and Matrix Medical.

91800138 Quick Release Conversion Kit

## Matrix VMS to VMS Plus Conversion Kit

Update your existing Matrix VMS anesthesia machine to a Matrix VMS Plus anesthesia machine.

91800167



Matrix VMS – Detail A Rear View



# Matrx VMC® Small Animal Anesthesia Machine

n/s	91303015	Maintenance Kit for Matrx VMS®, VMS® Plus, VMC®
1	62400314	Nut (3/8 - 16) (Tabletop units only)
2	77009124	Washer (3/8") (Tabletop units only)
3	62947401	Leveler (Tabletop units only)
4	65913901	Leveler Cap (Tabletop units only)
5	65928400	3" Caster
6	61902403	Spider Base, 5 Leg (Mobile units only)
7	65927000	Column Assembly (Mobile units only)
8	63500114	Screw (socket head 1/4 - 20 x 5/8")
9	62600206	Lock Washer (1/4")
10		Vaporizer (Not Included)
12		VMC Absorber Assembly
	91800040	VMC with a "V" serial number prefix
	029-5151-03	VMC without a "V" serial number prefix
14	63200102	O-Ring
15	10019700	Inlet Adapter, plated
16	20028600	Absorber Mount (right or left)
n/s	62600208	Absorber Mount Lock Washer
n/s	63500145	Absorber Mount Screw - 3/8-16 x 1"
17	91315076	5/16 ID Vap. Tubing (specify length in inches when ordering)
n/s	92305073	FS-2 Outlet Adapter
n/s	91315075	Black Neoprene Rubber Tubing, 1/4" ID (specify length in inches when ordering)
n/s	62900800	45° Hose Connector

## Matrx Quantiflex VMC® Head

13	40010201	USA
	40064101	ISO/Canadian

## Matrx Spartan VMC® Head

13	40072901	USA
	40074901	ISO/Canadian

## Matrx Quantiflex N<sub>2</sub>O Positive Stop Needle

### Valve Assembly (not shown)

63300513	USA
63300703	ISO/Canadian/Swedish

### O<sub>2</sub> Positive Stop Needle Valve Assembly (for all oxygen flowmeters - not shown)

63300512	USA
63300701	ISO/Canadian/Swedish

## Detail A – Side View VMC

1A	20028400	Upright Bar
2A	20028500	Back Bar
3A	91305093	FS-44 Spacer Kit for mounting
4A	63500102	Socket Head Screw - #6-32 x 3/8"
5A	62900101	O <sub>2</sub> - 45° Street Elbow
6A	92305043	O <sub>2</sub> DISS Connect (All except Swedish).
	10174300	O <sub>2</sub> DISS Connect (Swedish)
7A	30020200	Back Cover
8A	62900102	N <sub>2</sub> O - 45° Street Elbow 1/8 NPT
9A	91305041	N <sub>2</sub> O DISS Connect (All except Swedish)
	10173700	N <sub>2</sub> O DISS Connect (Swedish)
10A	62600404	Lockwasher
11A	62500107	Pan Head Screw
n/s	20013100	Stand Off
n/s	62600105	1/4 Flat Washer
n/s	62400104	1/4-20 Acorn Nut

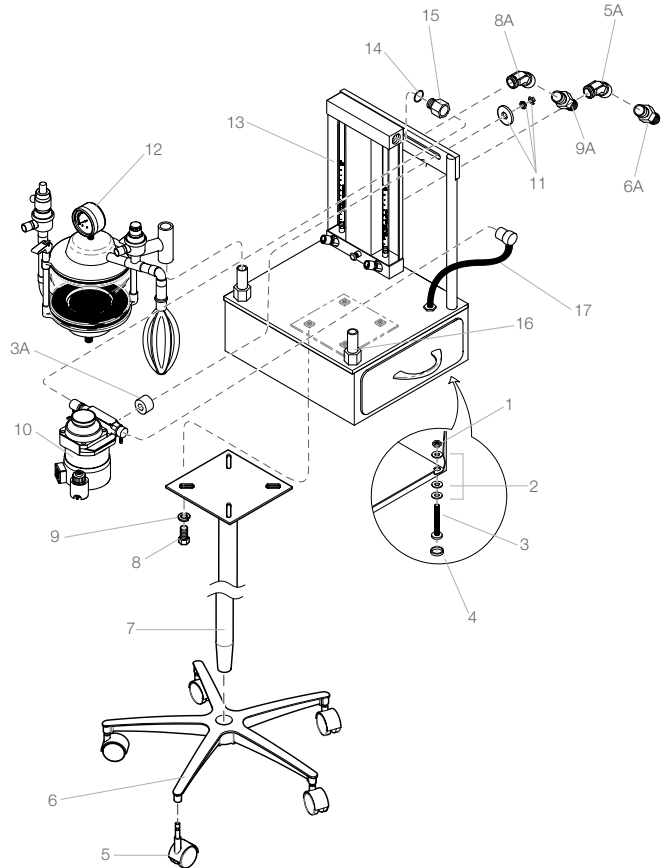

Matrx VMC – Detail A Side View

n/s = not able to show in illustration.

## Matrx VMS®/VMS® Plus

91800039 Matrx VMS® Absorber Assembly  
includes items 1-16

1	002-1702-00	APL Valve
2	92805012	Air Intake Valve
3	91800434	Pressure Gauge
n/s	91800435	Pressure Gauge Replacement Cover-Wexler (Included with 91800434)
n/s	91315276	Pressure Gauge Replacement Cover-Marshall
4	92316066	Upper Gasket
5	61919800	Screen (upper or lower)
6	92300519	Canister Assembly, includes canister, lower gasket/screen and fill label.
7	62905900	Fill Label
8	92316067	Lower Gasket
9	93805114	Occlusion Valve (VMS and VMS Plus only)
10	62400344	Hex Nut
11	10404200	Tie Rod
12	10046500	Sleeve
13	61100400	Compression Spring
14	65943500	Nylon Washer
15	10404000	"Quick Release" Lever
16	65929700	"Quick Release" Lever Pin
n/s	92805126	Canister w/Decal & Ring, No Gaskets
n/s	91525269	Optional Drain Valve Assembly
n/s	91525270	Replacement Pipe Plug Assembly

## Matrx VMC® Absorber

91800040 Matrx VMC Absorber Assembly  
includes items 1-16

1	002-1702-00	APL Valve
2	92805012	Air Intake Valve
3	91800434	Pressure Gauge
n/s	91800435	Pressure Gauge Replacement Cover-Wexler (Included with 91800434)
n/s	91315276	Pressure Gauge Replacement Cover-Marshall
4	92316066	Upper Gasket
5	61919800	Screen (upper or lower)
6	92300519	Canister Assembly, includes canister, lower gasket/screen and fill label.
7	62905900	Fill Label
8	92316067	Lower Gasket
9	93805114	Occlusion Valve (optional)
10	62400344	Hex Nut
11	10404200	Tie Rod
12	10046500	Sleeve
13	61100400	Compression Spring
14	65943500	Nylon Washer
15	10404000	"Quick Release" Lever
16	65929700	"Quick Release" Lever Pin
n/s	92805126	Canister w/Decal & Ring, No Gaskets

## Thumb Nut Absorber Replacement Parts

16	62400104	Acorn Nut 1/4 - 20
17	61400500	Thumb Nut
18	61201000	White Nylon Washer
19	61100400	Compression Spring
20	10046500	Sleeve
21	10046400	Adjusting Screw
22	10046201	Tie Rod

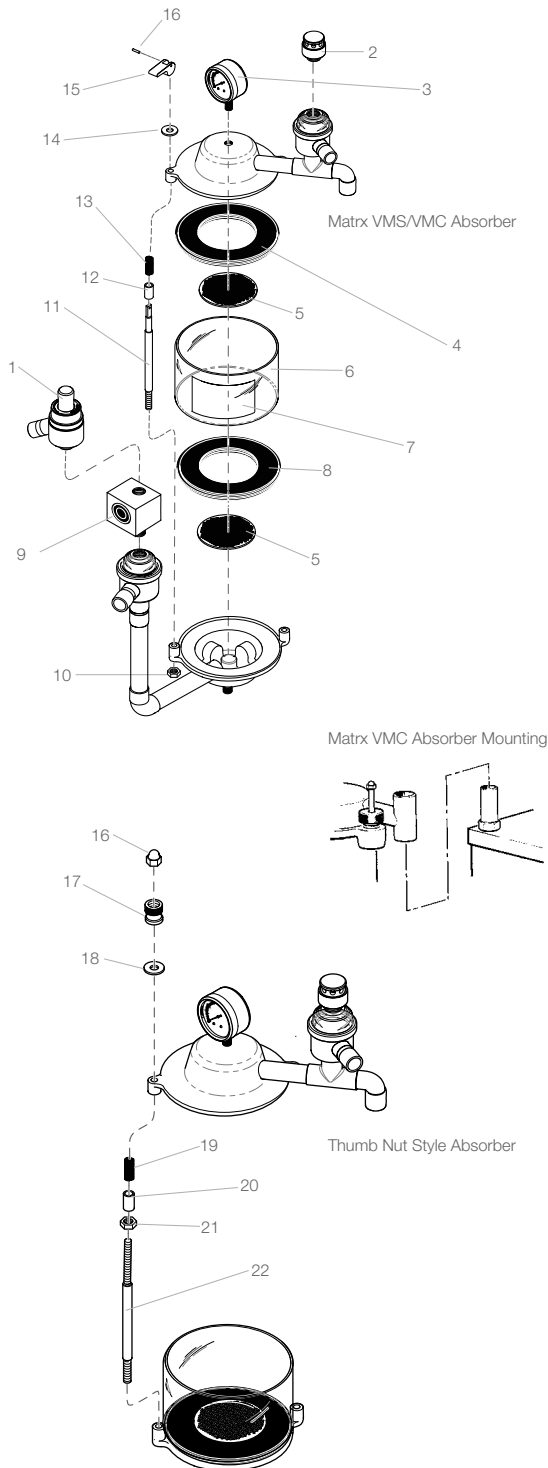

# Matrx VME2® Small Animal Anesthesia Machine

n/s	91303017	Maintenance Kit for Matrx VME2®/ VME®-Tabletop
1	63500182	Socket Head Bolt (1/4 - 20 x 5/8")
2	63500176	Screw (5/16 - 18 x 3/4")
3	62600207	Washer (lock)
4	62600120	Washer (flat 5/16)
6	91315075	Black Neoprene Rubber Tubing, 1/4" ID
7	61911000	"Y" Connector
8	92305072	FS2A Inlet Adapter
9	92305073	FS2 Outlet Adapter
10		Vaporizer (Not Included)
11	65928400	Caster
12	65928300	Spider Base, 5-Leg
13	61902507	Column
14	62700503	U Clamp (includes 5/16" x 18 nuts)
15	91316418	Absorber Canister w/Decal
16	62956200	Absorber Canister Gasket
17	62956200	Elbow (90 Deg Male - 1/4 HB x NPT Plated)
18	91800203	O <sub>2</sub> Flowmeter Assembly with Flush
19	65928200	Canister Knob
20	91800434	Pressure Gauge
21	91800655	Replacement O <sub>2</sub> Needle Valve Assembly with Positive Stop

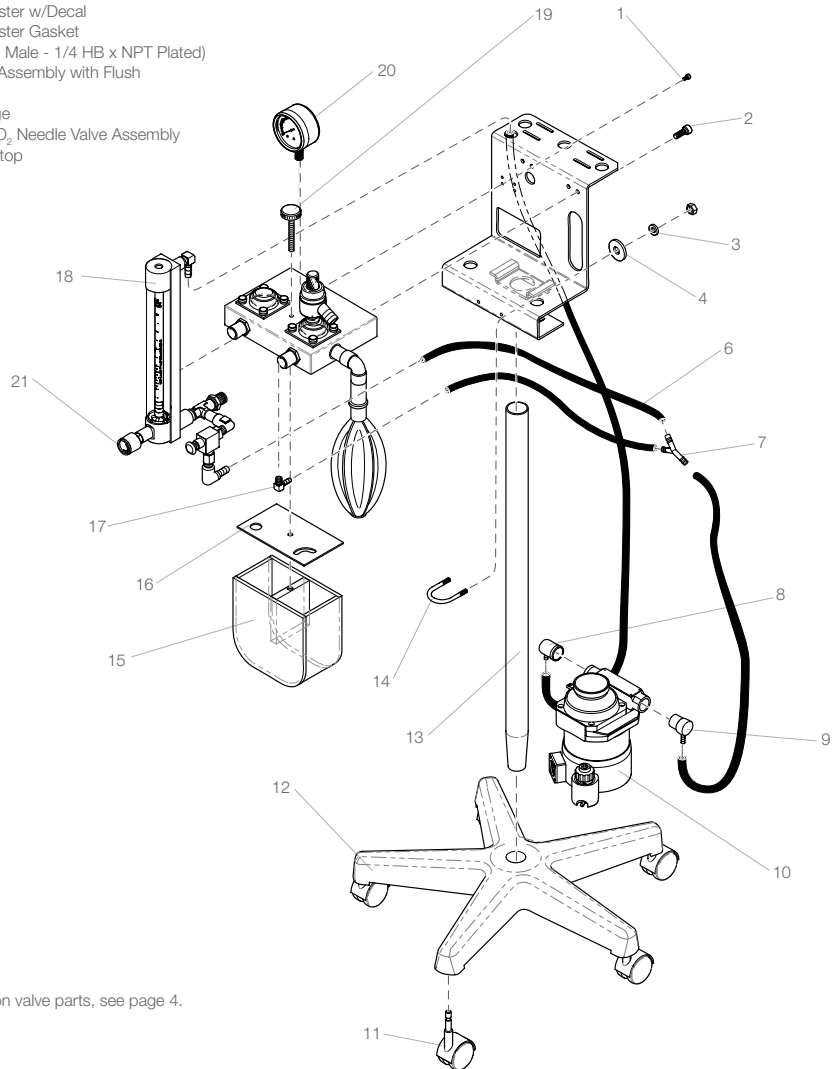

**NOTE:**  
For Matrx VME2 inhalation/exhalation valve parts, see page 4.

## Matrx VME® Small Animal Anesthesia Machine



n/s	91303016	Maintenance Kit for Matrx VME®- Stand Mount
1	65927800	Thumbscrew
2	91370171	Dome & Clamp, Inhalation Valve
3	91370172	Dome & Clamp, Exhalation Valve
4	63200113	O-Ring
5	10049000	Disc, Inhal. & Exhal. Valves
6	65928000	Flush Valve
7	93335196	APL Valve
8	91800434	Pressure Gauge
n/s	91800435	Pressure Gauge Replacement Cover-Wexler (Included with 91800434)
n/s	91315276	Pressure Gauge Replacement Cover-Marshall
9	65928200	Canister Knob
10	61902507	Column
11	65928300	Spider Base, 5 Leg
12	65928400	Caster
13	10395800	O <sub>2</sub> Tube
14	62954900	Canister Decal
15	62956200	Absorber Canister Gasket
16	91315075	Black Neoprene Rubber Tubing, 1/4" ID (specify length in inches when ordering)
17	62917008	1/4 HB x 1/8 NPT Elbow
18	62901100	1/8 NPT x 3/16 Tube Elbow
19	61911000	"Y" Connector
20	62900910	1/8M x 1/8F x 1/8F Pipe Tee
21	91305040	1/8 MPT O <sub>2</sub> Male DISS Connector
22	91316418	Absorber Canister w/Decal
23	92305072	FS2A Inlet Adapter
24	92305073	FS2 Outlet Adapter

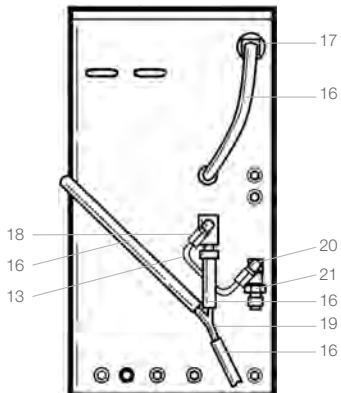

Matrx VME – Detail Rear View

# Matrx VME® Tabletop Small Animal Anesthesia Machine

n/s	91303017	Maintenance Kit for Matrx VME2®/ VME®-Tabletop
1	91800434	Pressure Gauge
n/s	91800435	Pressure Gauge Replacement Cover-Wexler (Included with 91800434)
n/s	91315276	Pressure Gauge Replacement Cover-Marshall
2	65928200	Canister Knob
3	62956200	Absorber Canister Gasket
4	61911000	"Y" Connector
5	91316418	Absorber Canister w/Decal
6	92305072	FS2A Inlet Adapter
7	92305073	FS2 Outlet Adapter
8	65936200	Handle Grip
9	10415300	Handle
10	63500176	Socket Head Screw, 5/16 - 18x3/4
11	62600207	HLCL Spring Lock Washer, 5/16, Plated
12	61930903	Tubing, 3"
13	61930909	Tubing, 6"
14	61930913	Tubing, 11"
15	61930916	Tubing, 5"
16	91800199	O <sub>2</sub> Flowmeter Assembly with Flush
17	62501705	Socket Head Shoulder Screw, #10-32
18	62919404	Curved Spring Washer - 1/4
19	62500124	Pan Head Screw, #10-32 x 5/8
20	65936300	Foot
21	62400309	Hex Nut, #10-32, Plated
22	63300512	O <sub>2</sub> Needle Valve Assembly
23	65936900	Bumper
24	10424202	Leg, Anodized
25	10503200	Screw kit for VMS, VME and VMR #10-32 x 5/16
26	62957002	Flowmeter Bracket, Anodized
27	63500114	Socket Head Screw, 1/4-20 x 5/8, Plated
28	62600502	Washer - 1/4
29	62400118	Acorn Nut, 1/4-20
30	62917008	1/4 HB x 1/8 NPT Elbow

**NOTE:**

For tabletop inhalation/exhalation valve parts, see page 4.



Matrx VME – Tabletop Front View

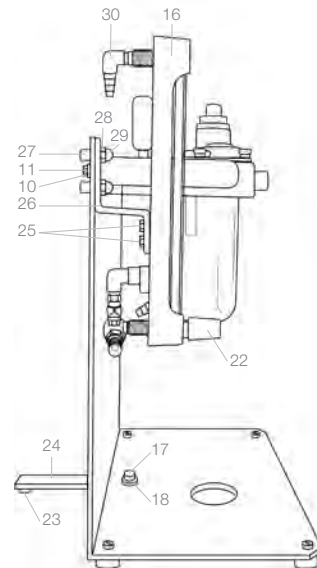

Matrx VME – Tabletop Side View

# Matrx VML® Large Animal Anesthesia Machine

## Matrx VML® Absorber Assembly

1	40010401	VML Basic Assembly
2	20221100	Corrugated Breathing Tube 64"
3	93815403	VML Inhaler "Y" with Retaining Ring
n/s	10008200	VML Inhaler "Y" Retaining Ring
4	92805421	(a) 22mm Endo Tube Connector
	92805425	(b) 25mm Endo Tube Connector
	92805434	(c) 30mm Endo Tube Connector
	92805435	(d) 40mm Endo Tube Connector
5	93815400	Breathing Bag (30L)
n/s	91305093	FS-44 Spacer Kit (not shown)
	10032500	(a) Plated Spacer (2)
	62600127	(b) Flat Washer (2)
	62503501	(c) Socket Set Screw (2)
	62600901	(d) Lock Washer (2)
	62400343	(e) Hex Nut (2)
7	91800434	Pressure Gauge
n/s	91800435	Pressure Gauge Replacement Cover-Wexler (Included with 91800434)
n/s	91315276	Pressure Gauge Replacement Cover-Marshall
8	30028400	Exh. Valve Assembly
9	91315075	Black Neoprene Rubber Tubing, 1/4" ID

## Matrx VML Stand Assembly Parts

10	92505017	15" Mounting Stud
11	62600204	Washer 5/8
12	62400318	Hex Nut 5/8
13	65936800	"T" Handle
14	20122401	Column Assembly
15	61902404	Spider Base, 5 Leg
16	65928400	3" Caster
n/s	91305280	Post Spacer
17	93805419	Canister Assembly
18	62400104	Acorn Nut 1/4-20
19	30028300	Inh. Valve Assembly
n/s	92305072	FS2A Inlet Adapter
n/s	61930907	Black Neoprene Rubber Tubing, 1/4" ID x 36"
n/s	63500115	Socket Head Screw 1/4-20 x 3/4
n/s	62600113	Washer
n/s	61911000	Nylon "Y" Connector

## Matrx VML-Detail A – Rear View

1A	30028200	Lower End Plate Assembly
2A	63200123	O-Ring (2-143)
3A	62500124	Pan Head Screw No. 10-32 x 5/8
4A	30027600	Gasket
5A	63500117	Socket Head Screw 1/4-20 x 1
6A	10555200	Screw kit for Matrx VML #10-32 x 3/8
7A	61300400	Drain Valve Assembly
8A	62900100	45° Street Elbow
9A	62900800	Hose Barb Connector
n/s	91305093	FS-44 Spacer Kit includes 2 hex head screws, 4 flat washers and 2 spacers

n/s = not able to show in illustration.

For Matrx VML inhalation/exhalation valve parts, see page 4.

For Matrx VML nitrous oxide/oxygen flowmeter assemblies and parts, see pages 2 and 3.



Matrx VML – Detail A Rear View





## Midmark Corporation

1700 South Patterson Boulevard  
Suite 400  
Dayton, Ohio 45409

Customer and Technical Services:  
Tel: 1-800-MIDMARK (1-800-643-6275)  
Fax: 1-877-725-6495  
midmark.com

## Versailles Facility

60 Vista Drive  
Versailles, OH 45380-0286

Tel: 1-800-MIDMARK (1-800-643-6275)  
Fax: 1-877-725-6496

## Lincolnshire Facility

675 Heathrow Drive  
Lincolnshire, IL 60069

Tel: 1-847-415-9800  
Fax: 1-847-415-9801

## Tampa Facility

10010 N. Dale Mabry Highway  
Suite 110  
Tampa, FL 33618

Tel: 1-800-MIDMARK (1-800-643-6275)  
Fax: 1-813-264-6218



<http://www.midmarkanimalhealth.com>

**Trade Name Notification** Canis Major, Matrx, VMS, VMS Plus, VMC, VME, VME2, VMR, VML, VIP 3000, VXP, Spartan, Quantiflex, Revive-A-Pet, VetPro, Cardell, CardEX, TidalGuard, Versaflo, UltraClave, and Soniclean are trademarks or registered trademarks of Midmark Corporation or its subsidiaries. Satelec, Acteon, Kydex, Athena Champion, Little Pro and Meisinger are all trademarks or registered trademarks of their respective companies. Other products or services may be trademarks or registered trademarks of their respective companies.

CARB 93120.2 Phase 2 Compliant

Midmark is an ISO 13485 and ISO 9001 Certified Company.

For more information or a demonstration, contact your Midmark dealer or call: 1-800-MIDMARK Fax: 1-877-725-6495  
Outside the U.S.A. call: 1-937-526-3662 Fax: 1-937-526-8214  
or visit our website at [midmarkanimalhealth.com](http://midmarkanimalhealth.com)

© 2009 Midmark Corporation  
60 Vista Drive Versailles, Ohio 45380-0286  
Products subject to improvement changes without notice  
Litho in U.S.A. 007-0739-00 Rev. F1 (2/14)



Because we care.