

“LEADER IN ANIMAL CARE PRODUCTS FOR OVER 60 YEARS”



**SSCI**

**SUBURBAN SURGICAL Co., INC.**

275 Twelfth Street, Wheeling, IL 60090

All intellectual material, including the text, graphics and other components of this catalog are Copyrighted by SSCI. Any use or duplication of these intellectual materials, without written consent by SSCI, is strictly forbidden.

**Catalog No. 702488-0308**

---

**For Product Information Call TOLL-FREE 1-800-323-7366 • (847) 537-9320 • Fax (847) 537-9061**  
**Hours: 8:30am - 5:00pm CST Monday - Friday**  
Visit our website at: [www.suburbansurgical.com](http://www.suburbansurgical.com)

# STAINLESS STEEL PREP-PROCEDURE TABLES

## CLASSIC PREP-PROCEDURE TABLES

STAINLESS STEEL TUBULAR BASE IS FOR EASY CLEAN-UP.

CLASSIC PREP-PROCEDURE TABLES ARE DESIGNED WITH THESE QUALITY FEATURES:

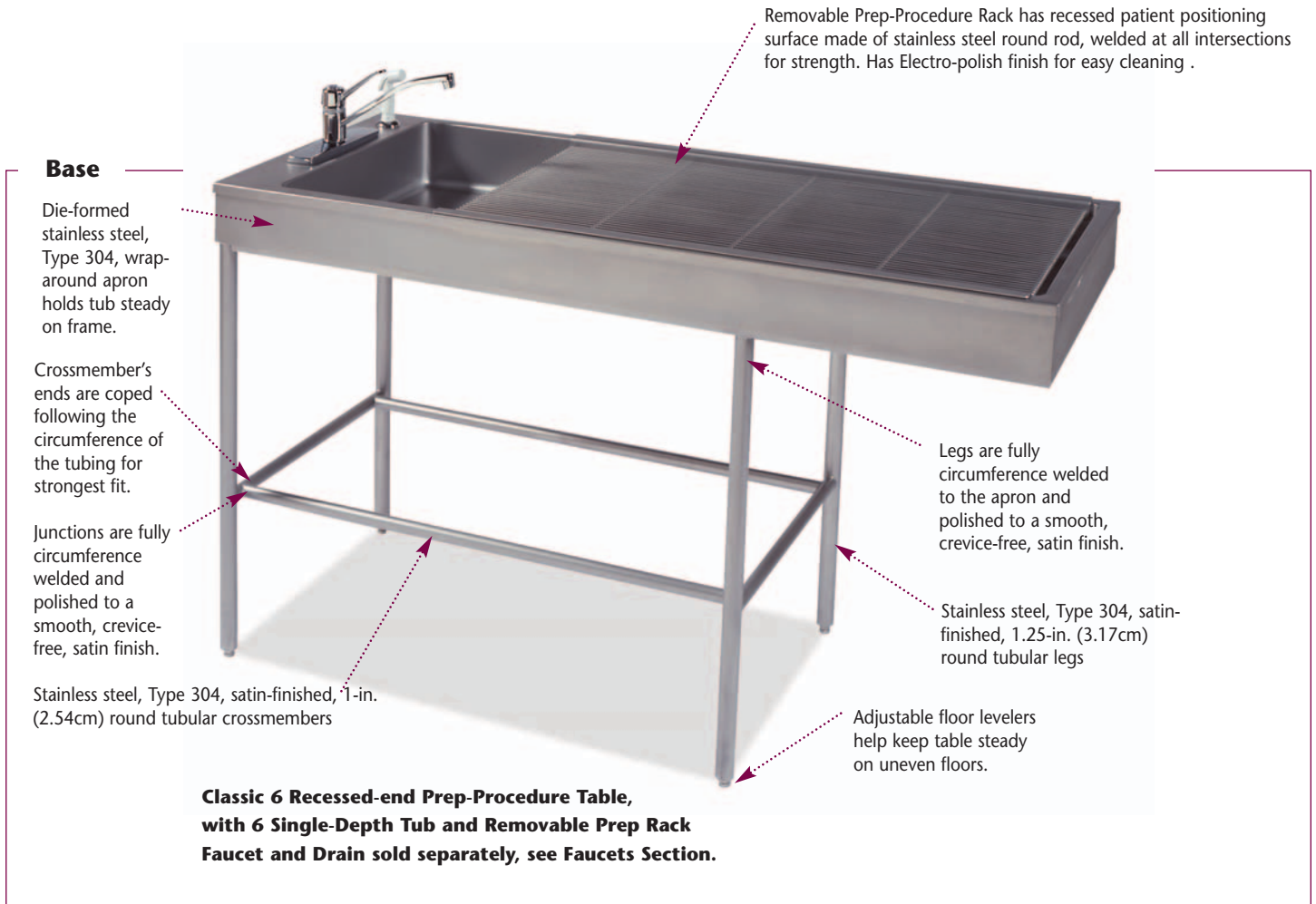

**Classic** Prep-Procedure Tables are ideal for wet areas or high humidity areas . Their durable, open, stainless steel construction eliminates places where moisture and bacteria can hide. Our selection of Prep-Procedure Tables includes two styles of tubs; choose from a **6 or 18 Single-Depth-style**, and a **6/18 Multi-Depth-style**. A removable Prep-Procedure Rack, which is designed for a secure fit, is included with each Prep-Procedure Table. All Prep-Procedure Tables are available in two widths; 48-in. (121.92cm) and 60-in. (152.40cm). Classic Prep-Procedure Table Bases are available in two styles; Full-width and Recessed-end. Full-width bases have a leg at each corner, Recessed-end

bases have a knee-space on either the left or the right. Tub rests in a die-formed frame around the perimeter of the base. Bases tubular crossmember's ends are coped at all junctions, following the circumference of the tubing, creating the strongest joint. Junctions are fully-circumferenced, crevice-free welded, sealing out fluids and debris; creating the strongest, one-piece. The entire base, including the welds are polished to a smooth, satin finish. Each leg is fitted with an adjustable leveler to keep table steady on uneven floors. Choose the style from the following pages to best meet your facility's needs.

# Stainless Steel Tubs For Prep-Procedure

**Our** 16-gauge, Type 304 Stainless Steel tubs are fully heli-arc welded into one piece to create the strongest tub available. Welds are continuous, crevice-free and ground smooth. Covered corners eliminate areas where dirt and debris accumulate. Radius bends on bottom and all sides and a uniform, non-glare finish results in a tub interior that is easy to clean. Tub is designed to accept a deck-mounted faucet with sprayer and 3.5-in. (8.89cm) drain.

Our selection of Prep-Procedure Tables includes two styles of tubs; choose from a **6 or 18 Single-Depth-style**, and a **6/18 Multi-Depth-style**. A removable Prep-Procedure Rack, which is designed for a secure fit, is included with each Prep-Procedure Table. All Prep-Procedure Tables are available in two widths; 48-in. (121.92cm) and 60-in. (152.40cm).

## SSCI TUBS ARE DESIGNED WITH THESE QUALITY FEATURES:

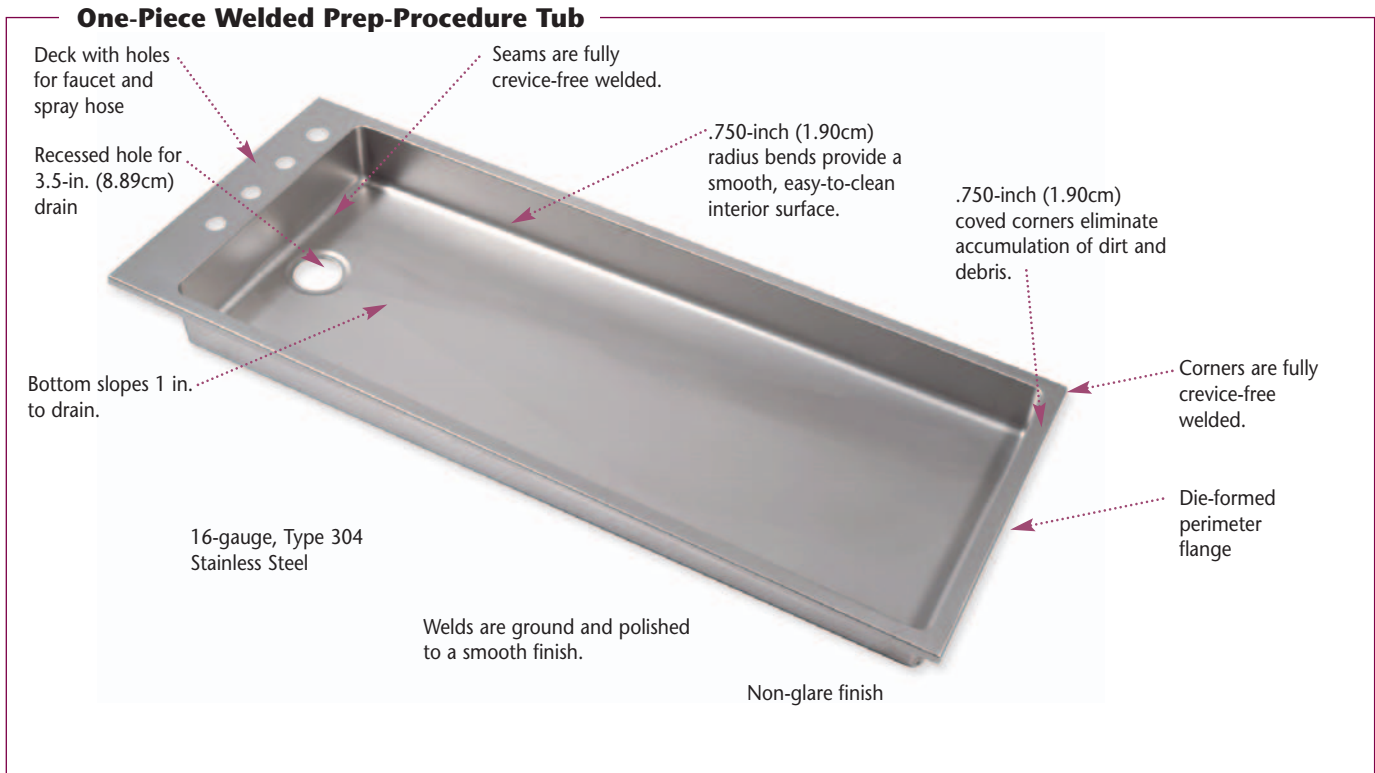

**Prep-Procedure Multi-Depth Tub**



**Prep-Procedure Single Depth Tub**

# Classic Prep-Procedure Tables



## Classic 6 Prep-Procedure Table

Features a 6 single-depth tub that works well for all procedures. The shallow depth makes this tub the easiest to clean - no bending to reach into a deep tub.

P/N	WIDTH		DEPTH		HEIGHT	
	In.	cm	In.	cm	In.	cm
12850-00-HJFNDR	48	121.92	24	60.96	36	91.44
12850-00-JFFNDR	60	152.40	24	60.96	36	91.44

**Classic 6 Prep-Procedure Table, with 6 Single-Depth Tub and Removable Prep Rack**  
Faucet and Drain sold separately, see **Faucets Section**. Shelf sold separately, see **Finishing Accessories, this Section**.



**Classic 18 Prep-Procedure Table, with 18 Single-Depth Tub and Removable Prep Rack**  
Faucet and Drain sold separately, see **Faucet Section**. Shelf sold separately, see **Finishing Accessories, this Section**.

## Classic 18 Prep-Procedure Table

Features an 18 single-depth tub designed for all procedures, plus tub depth permits dipping.

P/N	WIDTH		DEPTH		HEIGHT	
	In.	cm	In.	cm	In.	cm
12852-00-HJFNDR	48	121.92	24	60.96	36	91.44
12852-00-JFFNDR	60	152.40	24	60.96	36	91.44



## Classic 6 Recessed-End Prep-Procedure Table

Features a 6 single-depth tub in a base with a knee space for greater sit-down comfort.

P/N	WIDTH		DEPTH		HEIGHT	
	In.	cm	In.	cm	In.	cm
12851-00-HJFNDR	48	121.92	24	60.96	36	91.44
12851-00-JFFNDR	60	152.40	24	60.96	36	91.44

**Classic 6 Recessed-end Prep-Procedure Table, with 6 Single-Depth Tub and Removable Prep Rack**  
Faucet and Drain sold separately, see Faucets Section.



**Classic 6/18 Multi-Depth Recessed-end Prep-Procedure Table, with 6/18 Multi-Depth Tub and Removable Prep Rack**  
Faucet and Drains sold separately, see Faucets Section.

## Classic 6/18 Multi-Depth Recessed-End Prep-Procedure Table

Features a 6/18 Multi-depth tub designed for all procedures including dipping with a knee space to give you greater versatility for a variety of procedures with sit-down comfort.

P/N	WIDTH		DEPTH		HEIGHT	
	In.	cm	In.	cm	In.	cm
12853-00-HJFNDR	48	121.92	24	60.96	36	91.44
12853-00-JFFNDR	60	152.40	24	60.96	36	91.44

# LAMINATED AND STAINLESS STEEL PREP-PROCEDURE TABLES

**SELECT A IMPERIAL LAMINATED OR REGAL STAINLESS STEEL PREP-PROCEDURE TABLE TO KEEP SUPPLIES ORGANIZED AND CLOSE TO HAND**



**Imperial 6 Recessed-end Prep-Procedure Table, 6 Single-Depth Tub and Removable Prep Rack, Cupboard, Door Hinged Left + 4 Drawers + Knee Space Faucet, on Left; sold separately, see Faucets Section.**

**Our** selection of Prep-Procedure Tables includes two styles of tubs; choose from a **6 or 18 Single-Depth style**, and a **6/18 Multi-Depth style**. A removable Prep Rack, which is designed for a secure fit, is included with each Multi-Purpose Table. Now every SSCI recessed-end and full cabinet Prep-Procedure Table is available in both **Imperial** laminated or new **Regal** stainless steel models. SSCI's **Imperial** Prep-Procedure Tables coordinate with our Aristocrat Modular Cabinetry and matching Utility Columns; **Regal** Prep-Procedure Tables coordinate with our new **Regal** Modular Cabinetry and matching Utility Columns in appearance and both match every construction detail of their cabinet counterpart. All

Prep-Procedure Tables are available in two widths; 48-in. (121.92cm) and 60-in. (152.40cm), and are divided into 3 sections. Full Cabinet Prep-Procedure Tables include storage space in all 3 sections in a variety of drawer/cupboard combinations and Recessed-End Prep-Procedure Tables use one section on either the left or the right for knee space. Prep-Procedure Tables are typically purchased with tub only. SSCI Prep-Procedure Tables with abutted-style top and tub are designed to be used with SSCI Treatment Tables, Cabinets and Utility Columns. See Prep/Treatment Centers, Section 12. Tops are available in either stainless steel or laminated models.

There are 5 steps to selecting the perfect Prep-Procedure Table for your facility.

*Select from illustrations on following pages :*

- 1) Recessed-End or Full Cabinet-Style Prep-Procedure Table.
- 2) Drawers and/or cupboard combinations.
- 3) **Imperial** laminated or **Regal** stainless steel-model Prep-Procedure Table.
- 4) 48-in. (121.92cm) or 60-in. (152.40cm) wide cabinet
- 5) Tub, stainless steel abutted top and tub or laminated abutted top and tub



**Regal 6 Prep-Procedure Table**  
**6 Single-Depth Tub and Removable Prep Rack,**  
**Cupboard, Door Hinged Left + 3 Drawers + 3 Drawers**  
**Faucet, on Right; sold separately, see Faucets Section.**

**Imperial** Prep-Procedure Table body panels are constructed of 45-lb. industrial-grade substrate, panels are machined on a CNC machine for accuracy. Panels are dadoed and rabbeted for tight-fitting joints. Joints are glued with adhesive impervious to liquids and mechanically-fastened to ensure a solid, sturdy cabinet.

All cabinet interiors are finished with Thermo-Fused Melamine, making them water, odor and chemical-resistant.

Drawer's steel sides feature integrated roller slides with baked-on, white epoxy finish. Drawer's back/bottom are .625-in. thick; open/close easily with 100 lb. load. 3D micro-adjustment ensures drawer alignment.

Door's positive-action, invisible hinges have self-closing mechanism, also holds door open. 3D micro-adjustment ensures door alignment. Doors and drawer fronts have full width Aluminum Pulls.

All finished, exterior surfaces including the body's edges, drawer and cupboard door edges are laminated with high-pressure plastic laminate, available in SSCI Standard colors, or SSCI optional colors or choose from a spectrum of customer-selected colors to blend with your décor.

**Regal** Prep-Procedure Table body panels are constructed of die-formed stainless steel, panels are formed on a CNC machine for accuracy. Panels are engineered for tight-fitting joints. Joints are welded and mechanically-fastened to ensure a solid, sturdy cabinet. All cabinet interiors are stainless steel, making them impervious to water and absorbing odors.

Drawer's front is double-wall stainless steel construction with a full-width pull incorporated into the design. Welded, one-piece drawer body is stainless steel with roller telescoping slides allow drawers to fully open/close easily with 100 lb. load.

Doors are double-wall stainless steel construction with a full-width pull incorporated into the design and features positive-action invisible hinges which have self-closing mechanism, also holds door open. 3D micro-adjustment ensures door alignment.

Doors and drawer fronts have full width Stainless Steel Pulls.

All stainless steel exterior/interior is durable and easy to clean, satin finish.

# Imperial Prep-Procedure Tables

## IMPERIAL LAMINATED CABINET PREP-PROCEDURE TABLES INCLUDE THESE FEATURES:

**Imperial 6 Recessed End Prep-Procedure Tables  
6 Single-Depth Tub and Removable Prep Rack,  
Cupboard, Door Hinged Left + 4 Drawers + Knee Space  
Faucet, on Left; sold separately, see Faucets Section.**

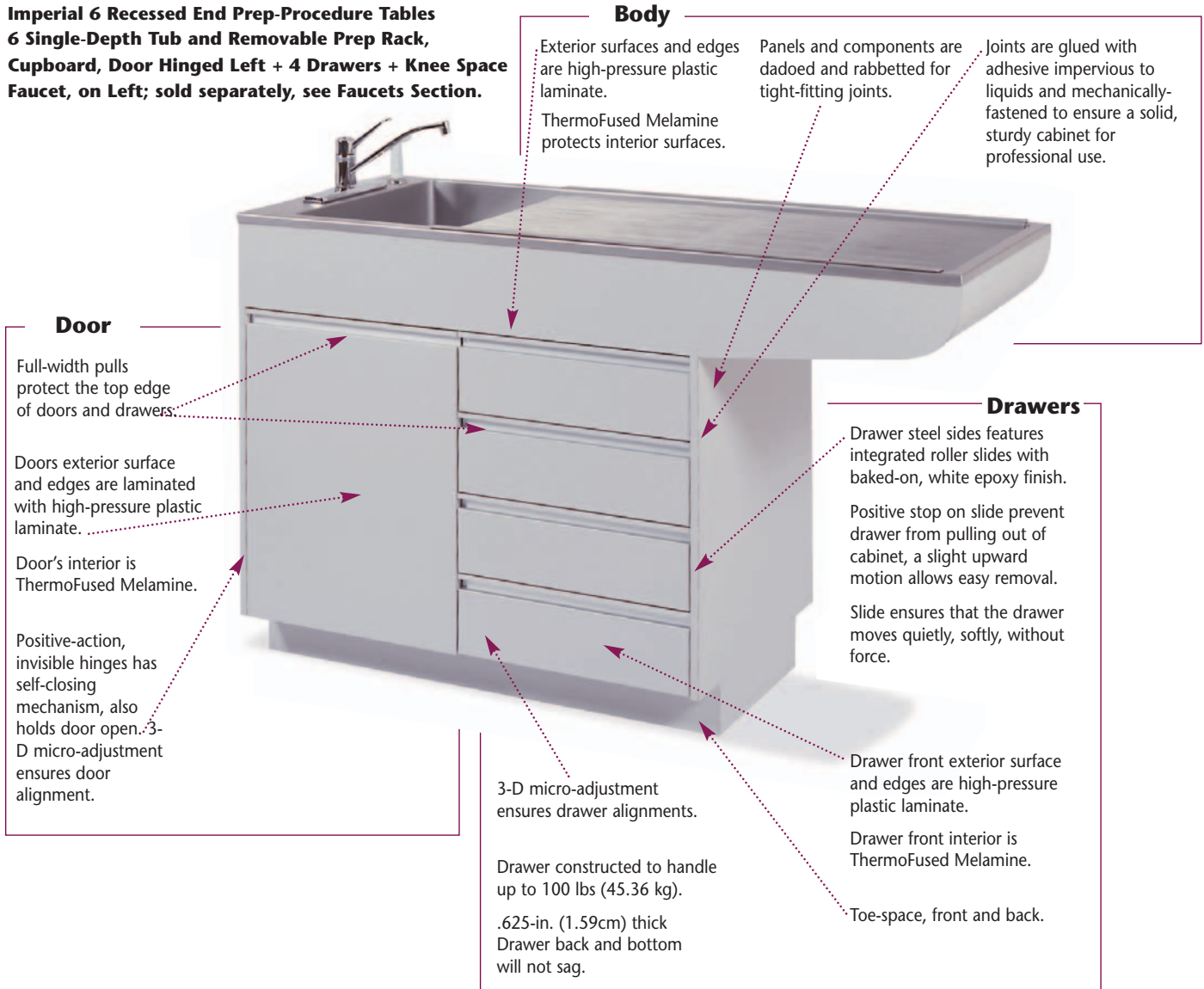

### Body

Exterior surfaces and edges are high-pressure plastic laminate.  
ThermoFused Melamine protects interior surfaces.

Panels and components are dadoed and rabbetted for tight-fitting joints.

Joints are glued with adhesive impervious to liquids and mechanically-fastened to ensure a solid, sturdy cabinet for professional use.

### Door

Full-width pulls protect the top edge of doors and drawers.

Doors exterior surface and edges are laminated with high-pressure plastic laminate.

Door's interior is ThermoFused Melamine.

Positive-action, invisible hinges has self-closing mechanism, also holds door open. 3-D micro-adjustment ensures door alignment.

### Drawers

Drawer steel sides features integrated roller slides with baked-on, white epoxy finish.

Positive stop on slide prevent drawer from pulling out of cabinet, a slight upward motion allows easy removal.

Slide ensures that the drawer moves quietly, softly, without force.

Drawer front exterior surface and edges are high-pressure plastic laminate.

Drawer front interior is ThermoFused Melamine.

Toe-space, front and back.

3-D micro-adjustment ensures drawer alignments.

Drawer constructed to handle up to 100 lbs (45.36 kg).

.625-in. (1.59cm) thick  
Drawer back and bottom will not sag.

**All** Imperial/Regal Prep-Procedure Tables are available with a tub only or with an Abutted top and tub; in stainless steel or laminated. Both models can be used in situations where an abutting table is needed.

*Tub only* — Creates a smooth, flush fit between the cabinet and tub, eliminating a ledge and extra surfaces to clean. Prep-Procedure Tables are typically purchased with tubs only.



**Tub and Table**

Tub is flush with table's front, back and both ends.





**REGAL STAINLESS STEEL CABINET PREP-PROCEDURE TABLES  
INCLUDE THESE FEATURES:**



**Regal 6 Recessed End Prep-Procedure Tables  
6 Single-Depth Tub and Removable Prep Rack,  
Knee space + 3 Drawers + Cupboard, Door Hinged Right  
Faucet, on Right; sold separately, see Faucets Section.**

*Abutted Top* — For use if you want to match treatment Table's top when used together in Prep-Procedure/Treatment Centers. See Prep-Procedure/Treatment Centers, Section 12.

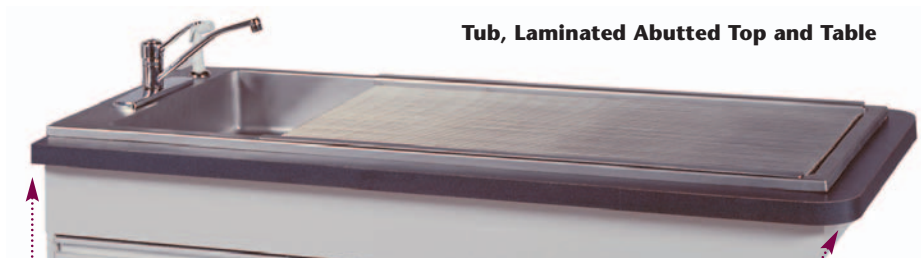

**Tub, Laminated Abutted Top and Table**

Top flush with cabinet, one end

Top over-hangs table's front, back and one end:

**For Product Information Call TOLL-FREE 1-800-323-7366 • (847) 537-9320 • Fax (847) 537-9061  
Hours: 8:30am - 5:00pm CST Monday - Friday  
Visit our website at: [www.suburbansurgical.com](http://www.suburbansurgical.com)**

# Imperial/Regal 6 Recessed End Prep-Procedure Tables



**Imperial 6 Recessed End Prep-Procedure Table**  
**6 Single-Depth Tub and Removable Prep Rack,**  
**Cupboard, Door Hinged Left + 4 Drawers + Knee Space**  
**Faucet, on Left; sold separately, see Faucets Section.**



## Imperial/Regal 6 Recessed End Prep-Procedure Tables

All Recessed-end Prep-Procedure Tables include our 6 Single-depth tub and removable Prep Rack. The cabinet is divided into 3 sections; two sections are storage space in a variety of drawer/cupboard combinations and a recessed knee space uses one section on the left or right end.

We offer these Tables with your choice of a durable, top-quality, high-pressure laminated **Imperial** Cabinet, or an all stainless steel **Regal** Cabinet for unsurpassed durability. **Imperial** laminated Tables are available in SSCI Standard colors, or SSCI optional colors or choose from a spectrum of customer-selected colors to blend with your décor. Tables are available with tub only or with a countertop and tub. Choose either stainless steel or laminated countertops.



**Regal 6 Recessed End Prep-Procedure Table**  
**6 Single-Depth Tub and Removable Prep Rack,**  
**Knee Space +3 Drawers +Cupboard, Door Hinged Right**  
**Faucet, on Right; sold separately, see Faucets Section.**

# Imperial/Regal 6 Single-Depth Tub Recessed End Prep-Procedure Tables

P/N	TOP STYLE	COLOR	
		CABINET	TOP
<b>IMPERIAL LAMINATED CABINET</b>			
48-in. (121.92cm) wide Laminated Cabinet			
L10AA04B1U0E0A3	Tub	- - - - †	N/A
L10HB04B1U0E0A3	SS Abutted Top & Tub	- - - - †	N/A
L10HH04B1U0E0A3	Laminated Abutted Top & Tub	- - - - †	- - - - †
60-in. (152.40cm) wide Laminated Cabinet			
L10AA04B1U0E0A5	Tub	- - - - †	N/A
L10HB04B1U0E0A5	SS Abutted Top & Tub	- - - - †	N/A
L10HH04B1U0E0A5	Laminated Abutted Top & Tub	- - - - †	- - - - †
<b>REGAL STAINLESS STEEL CABINET</b>			
48-in. (121.92cm) wide Stainless Steel Cabinet			
Y10AA04B1U0E0A3	Tub	N/A	N/A
Y10HB04B1U0E0A3	SS Abutted Top & Tub	N/A	N/A
Y10HH04B1U0E0A3	Laminated Abutted Top & Tub	N/A	- - - - †
60-in. (152.40cm) wide Stainless Steel Cabinet			
Y10AA04B1U0E0A5	Tub	N/A	N/A
Y10HB04B1U0E0A5	SS Abutted Top & Tub	N/A	N/A
Y10HH04B1U0E0A5	Laminated Abutted Top & Tub	N/A	- - - - †

## Knee Space + 3 Drawers + Cupboard, Door Hinged Right 6 Single-Depth Tub, Faucet Right

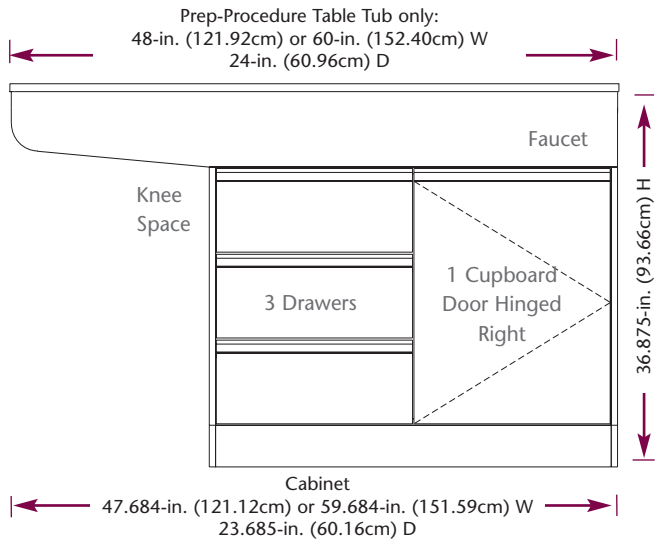

P/N	TOP STYLE	COLOR	
		CABINET	TOP
<b>IMPERIAL LAMINATED CABINET</b>			
48-in. (121.92cm) wide Laminated Cabinet			
L10AA03D0U0B1A3	Tub	- - - - †	N/A
L10HB03D0U0B1A3	SS Abutted Top & Tub	- - - - †	N/A
L10HH03D0U0B1A3	Laminated Abutted Top & Tub	- - - - †	- - - - †
60-in. (152.40cm) wide Laminated Cabinet			
L10AA03D0U0B1A5	Tub	- - - - †	N/A
L10HB03D0U0B1A5	SS Abutted Top & Tub	- - - - †	N/A
L10HH03D0U0B1A5	Laminated Abutted Top & Tub	- - - - †	- - - - †
<b>REGAL STAINLESS STEEL CABINET</b>			
48-in. (121.92cm) wide Stainless Steel Cabinet			
Y10AA03D0U0B1A3	Tub	N/A	N/A
Y10HB03D0U0B1A3	SS Abutted Top & Tub	N/A	N/A
Y10HH03D0U0B1A3	Laminated Abutted Top & Tub	N/A	- - - - †
60-in. (152.40cm) wide Stainless Steel Cabinet			
Y10AA03D0U0B1A5	Tub	N/A	N/A
Y10HB03D0U0B1A5	SS Abutted Top & Tub	N/A	N/A
Y10HH03D0U0B1A5	Laminated Abutted Top & Tub	N/A	- - - - †

## Cupboard, Door Hinged Left + 3 Drawers + Knee Space 6 Single-Depth Tub, Faucet Left

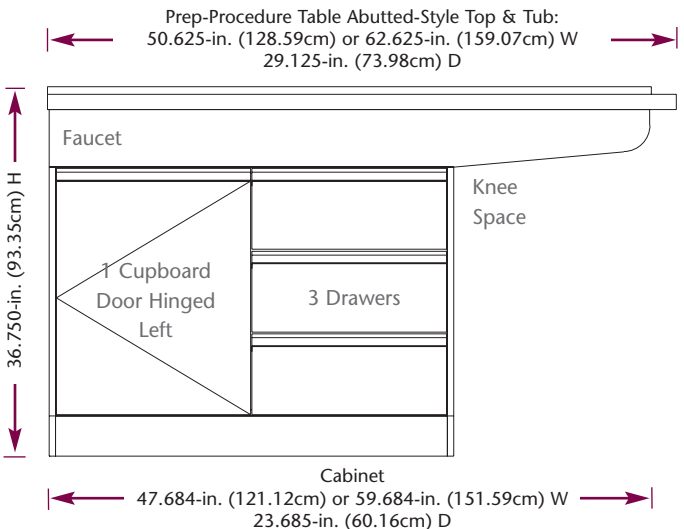

**Important:** These customer order requirements, in addition to other customer order requirements, must be satisfied prior to the beginning of manufacturing lead time:

†Specify 4-digit Color code. See Color Selections, Section A, pages 1 & 2 for Color Codes.



SSCI laminated products are available in SSCI standard laminates, SSCI optional laminates, or Customer selected laminates.

**For Product Information Call TOLL-FREE 1-800-323-7366 • (847) 537-9320 • Fax (847) 537-9061**

**Hours: 8:30am - 5:00pm CST Monday - Friday**

Visit our website at: [www.suburbansurgical.com](http://www.suburbansurgical.com)

# Imperial/Regal 6 Single-Depth Tub Recessed End Prep-Procedure Tables

## Knee Space + 4 Drawers + Cupboard, Door Hinged Right 6 Single-Depth Tub, Faucet Right

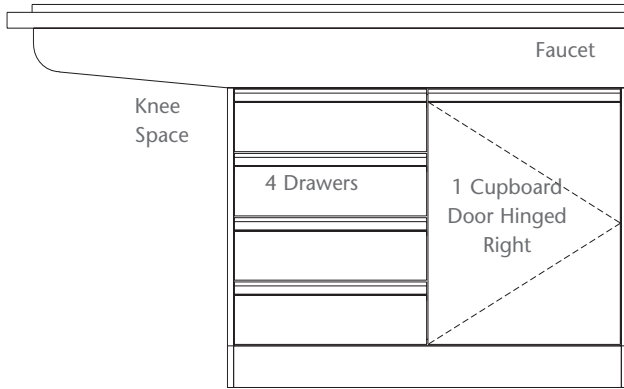

P/N	TOP STYLE	COLOR	
		CABINET	TOP
<b>IMPERIAL LAMINATED CABINET</b>			
<b>48-in. (121.92cm) wide Laminated Cabinet</b>			
L10AA04B1V0E0A3	Tub	- _ _ _ †	N/A
L10HB04B1V0E0A3	SS Abutted Top & Tub	- _ _ _ †	N/A
L10HH04B1V0E0A3	Laminated Abutted Top & Tub	- _ _ _ †	- _ _ _ †
<b>60-in. (152.40cm) wide Laminated Cabinet</b>			
L10AA04B1V0E0A5	Tub	- _ _ _ †	N/A
L10HB04B1V0E0A5	SS Abutted Top & Tub	- _ _ _ †	N/A
L10HH04B1V0E0A5	Laminated Abutted Top & Tub	- _ _ _ †	- _ _ _ †
<b>REGAL STAINLESS STEEL CABINET</b>			
<b>48-in. (121.92cm) wide Stainless Steel Cabinet</b>			
Y10AA04B1V0E0A3	Tub	N/A	N/A
Y10HB04B1V0E0A3	SS Abutted Top & Tub	N/A	N/A
Y10HH04B1V0E0A3	Laminated Abutted Top & Tub	N/A	- _ _ _ †
<b>60-in. (152.40cm) wide Stainless Steel Cabinet</b>			
Y10AA04B1V0E0A5	Tub	N/A	N/A
Y10HB04B1V0E0A5	SS Abutted Top & Tub	N/A	N/A
Y10HH04B1V0E0A5	Laminated Abutted Top & Tub	N/A	- _ _ _ †

## Cupboard, Door Hinged Left + 4 Drawers + Knee Space 6 Single-Depth Tub, Faucet Left

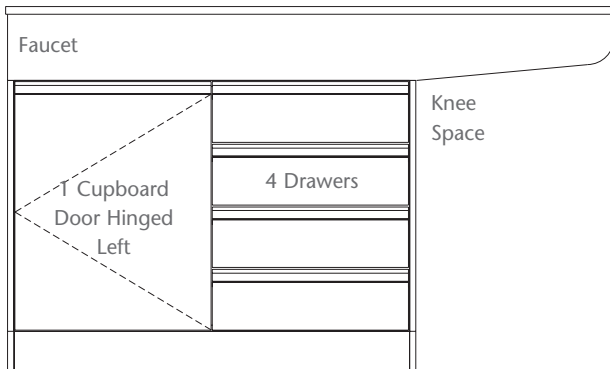

P/N	TOP STYLE	COLOR	
		CABINET	TOP
<b>IMPERIAL LAMINATED CABINET</b>			
<b>48-in. (121.92cm) wide Laminated Cabinet</b>			
L10AA03D0V0B1A3	Tub	- _ _ _ †	N/A
L10HB03D0V0B1A3	SS Abutted Top & Tub	- _ _ _ †	N/A
L10HH03D0V0B1A3	Laminated Abutted Top & Tub	- _ _ _ †	- _ _ _ †
<b>60-in. (152.40cm) wide Laminated Cabinet</b>			
L10AA03D0V0B1A5	Tub	- _ _ _ †	N/A
L10HB03D0V0B1A5	SS Abutted Top & Tub	- _ _ _ †	N/A
L10HH03D0V0B1A5	Laminated Abutted Top & Tub	- _ _ _ †	- _ _ _ †
<b>REGAL STAINLESS STEEL CABINET</b>			
<b>48-in. (121.92cm) wide Stainless Steel Cabinet</b>			
Y10AA03D0V0B1A3	Tub	N/A	N/A
Y10HB03D0V0B1A3	SS Abutted Top & Tub	N/A	N/A
Y10HH03D0V0B1A3	Laminated Abutted Top & Tub	N/A	- _ _ _ †
<b>60-in. (152.40cm) wide Stainless Steel Cabinet</b>			
Y10AA03D0V0B1A5	Tub	N/A	N/A
Y10HB03D0V0B1A5	SS Abutted Top & Tub	N/A	N/A
Y10HH03D0V0B1A5	Laminated Abutted Top & Tub	N/A	- _ _ _ †

**Important:** These customer order requirements, in addition to other customer order requirements, must be satisfied prior to the beginning of manufacturing lead time:  
 †Specify 4-digit Color code. See Color Selections, Section A, pages 1 & 2 for Color Codes.



SSCI laminated products are available in SSCI standard laminates, SSCI optional laminates, or Customer selected laminates.

# Imperial/Regal 6 Single-Depth Tub Recessed End Prep-Procedure Tables

P/N	TOP STYLE	COLOR	
		CABINET	TOP
<b>IMPERIAL LAMINATED CABINET</b>			
<b>48-in. (121.92cm) wide Laminated Cabinet</b>			
L10AA04B1A0G0A3	Tub	- - - - †	N/A
L10HB04B1A0G0A3	SS Abutted Top & Tub	- - - - †	N/A
L10HH04B1A0G0A3	Laminated Abutted Top & Tub	- - - - †	- - - - †
<b>60-in. (152.40cm) wide Laminated Cabinet</b>			
L10AA04B1A0G0A5	Tub	- - - - †	N/A
L10HB04B1A0G0A5	SS Abutted Top & Tub	- - - - †	N/A
L10HH04B1A0G0A5	Laminated Abutted Top & Tub	- - - - †	- - - - †
<b>REGAL STAINLESS STEEL CABINET</b>			
<b>48-in. (121.92cm) wide Stainless Steel Cabinet</b>			
Y10AA04B1A0G0A3	Tub	N/A	N/A
Y10HB04B1A0G0A3	SS Abutted Top & Tub	N/A	N/A
Y10HH04B1A0G0A3	Laminated Abutted Top & Tub	N/A	- - - - †
<b>60-in. (152.40cm) wide Stainless Steel Cabinet</b>			
Y10AA04B1A0G0A5	Tub	N/A	N/A
Y10HB04B1A0G0A5	SS Abutted Top & Tub	N/A	N/A
Y10HH04B1A0G0A5	Laminated Abutted Top & Tub	N/A	- - - - †

## Knee Space + Cupboard, Pair of Hinged Doors 6 Single-Depth Tub, Faucet Right

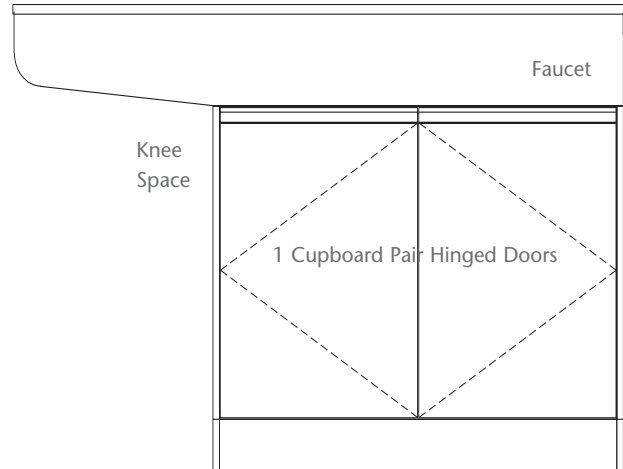

P/N	TOP STYLE	COLOR	
		CABINET	TOP
<b>IMPERIAL LAMINATED CABINET</b>			
<b>48-in. (121.92cm) wide Laminated Cabinet</b>			
L10AA03G0A0B1A3	Tub	- - - - †	N/A
L10HB03G0A0B1A3	SS Abutted Top & Tub	- - - - †	N/A
L10HH03G0A0B1A3	Laminated Abutted Top & Tub	- - - - †	- - - - †
<b>60-in. (152.40cm) wide Laminated Cabinet</b>			
L10AA03G0A0B1A5	Tub	- - - - †	N/A
L10HB03G0A0B1A5	SS Abutted Top & Tub	- - - - †	N/A
L10HH03G0A0B1A5	Laminated Abutted Top & Tub	- - - - †	- - - - †
<b>REGAL STAINLESS STEEL CABINET</b>			
<b>48-in. (121.92cm) wide Stainless Steel Cabinet</b>			
Y10AA03G0A0B1A3	Tub	N/A	N/A
Y10HB03G0A0B1A3	SS Abutted Top & Tub	N/A	N/A
Y10HH03G0A0B1A3	Laminated Abutted Top & Tub	N/A	- - - - †
<b>60-in. (152.40cm) wide Stainless Steel Cabinet</b>			
Y10AA03G0A0B1A5	Tub	N/A	N/A
Y10HB03G0A0B1A5	SS Abutted Top & Tub	N/A	N/A
Y10HH03G0A0B1A5	Laminated Abutted Top & Tub	N/A	- - - - †

## Cupboard, Pair of Hinged Doors + Knee Space 6 Single-Depth Tub, Faucet Left

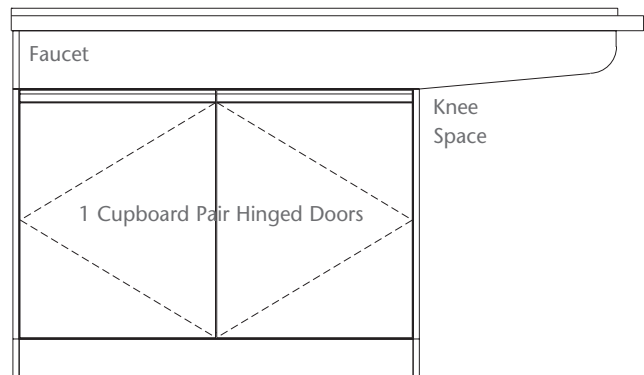

**Important:** These customer order requirements, in addition to other customer order requirements, must be satisfied prior to the beginning of manufacturing lead time:  
 †Specify 4-digit Color code. See Color Selections, Section A, pages 1 & 2 for Color Codes.



SSCI laminated products are available in SSCI standard laminates, SSCI optional laminates, or Customer selected laminates.

# Imperial/Regal 6 Single-Depth Tub Recessed End Prep-Procedure Tables

## Knee Space + Cupboard, Door Hinged Right + Cupboard, Door Hinged Right 6 Single-Depth Tub, Faucet Right

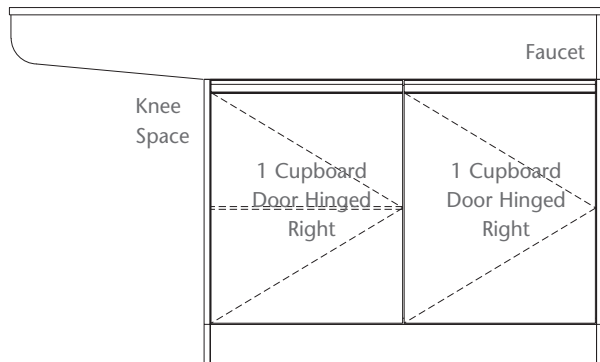

P/N	TOP STYLE	COLOR	
		CABINET	TOP
<b>IMPERIAL LAMINATED CABINET</b>			
48-in. (121.92cm) wide Laminated Cabinet			
L10AA04B1E0E0A3	Tub	- - - - †	N/A
L10HB04B1E0E0A3	SS Abutted Top & Tub	- - - - †	N/A
L10HH04B1E0E0A3	Laminated Abutted Top & Tub	- - - - †	- - - - †
60-in. (152.40cm) wide Laminated Cabinet			
L10AA04B1E0E0A5	Tub	- - - - †	N/A
L10HB04B1E0E0A5	SS Abutted Top & Tub	- - - - †	N/A
L10HH04B1E0E0A5	Laminated Abutted Top & Tub	- - - - †	- - - - †
<b>REGAL STAINLESS STEEL CABINET</b>			
48-in. (121.92cm) wide Stainless Steel Cabinet			
Y10AA04B1E0E0A3	Tub	N/A	N/A
Y10HB04B1E0E0A3	SS Abutted Top & Tub	N/A	N/A
Y10HH04B1E0E0A3	Laminated Abutted Top & Tub	N/A	- - - - †
60-in. (152.40cm) wide Stainless Steel Cabinet			
Y10AA04B1E0E0A5	Tub	N/A	N/A
Y10HB04B1E0E0A5	SS Abutted Top & Tub	N/A	N/A
Y10HH04B1E0E0A5	Laminated Abutted Top & Tub	N/A	- - - - †

## Cupboard, Door Hinged Left + Cupboard, Door Hinged Left + Knee Space 6 Single-Depth Tub, Faucet Left

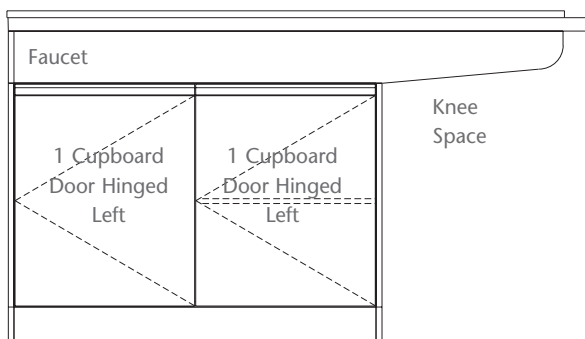

P/N	TOP STYLE	COLOR	
		CABINET	TOP
<b>IMPERIAL LAMINATED CABINET</b>			
48-in. (121.92cm) wide Laminated Cabinet			
L10AA03D0D0B1A3	Tub	- - - - †	N/A
L10HB03D0D0B1A3	SS Abutted Top & Tub	- - - - †	N/A
L10HH03D0D0B1A3	Laminated Abutted Top & Tub	- - - - †	- - - - †
60-in. (152.40cm) wide Laminated Cabinet			
L10AA03D0D0B1A5	Tub	- - - - †	N/A
L10HB03D0D0B1A5	SS Abutted Top & Tub	- - - - †	N/A
L10HH03D0D0B1A5	Laminated Abutted Top & Tub	- - - - †	- - - - †
<b>REGAL STAINLESS STEEL CABINET</b>			
48-in. (121.92cm) wide Stainless Steel Cabinet			
Y10AA03D0D0B1A3	Tub	N/A	N/A
Y10HB03D0D0B1A3	SS Abutted Top & Tub	N/A	N/A
Y10HH03D0D0B1A3	Laminated Abutted Top & Tub	N/A	- - - - †
60-in. (152.40cm) wide Stainless Steel Cabinet			
Y10AA03D0D0B1A5	Tub	N/A	N/A
Y10HB03D0D0B1A5	SS Abutted Top & Tub	N/A	N/A
Y10HH03D0D0B1A5	Laminated Abutted Top & Tub	N/A	- - - - †

**Important:** These customer order requirements, in addition to other customer order requirements, must be satisfied prior to the beginning of manufacturing lead time:  
 †Specify 4-digit Color code. See Color Selections, Section A, pages 1 & 2 for Color Codes.



SSCI laminated products are available in SSCI standard laminates, SSCI optional laminates, or Customer selected laminates.

## Imperial/Regal 6 Single-Depth Tub Recessed Middle Prep-Procedure Tables



**Imperial 6 Recessed Middle Prep-Procedure Table  
6 Single-Depth Tub and Removable Prep Rack,  
3 Drawers + Knee Space + Cupboard, Door Hinged Right  
Faucet, on Right; sold separately, see Faucets Section.**

### Imperial/Regal 6 Recessed Middle Prep-Procedure Tables

All Recessed-middle Prep-Procedure Tables include our 6 Single-depth tub and removable Prep Rack. The cabinet is divided into 3 sections; two sections are storage space in a variety of drawer/cupboard combinations and a recessed knee space uses one section in the middle, allowing you to sit comfortably during procedures and still have easy access to supplies in the drawers or cupboards on either side.

We offer these Tables with your choice of a durable, top-quality, high-pressure laminated **Imperial** Cabinet, or an all stainless steel **Regal** Cabinet for unsurpassed durability. **Imperial** laminated Tables are available in SSCI Standard colors, or SSCI optional colors or choose from a spectrum of customer-selected colors to blend with your décor. Tables are available with tub only or with a countertop and tub. Choose either stainless steel or laminated countertops.



**Regal 6 Recessed Middle Prep-Procedure Table  
6 Single-Depth Tub and Removable Prep Rack,  
Cupboard, Door Hinged Left + Knee Space + 3 Drawers,  
Faucet, on Right; sold separately, see Faucets Section.**

# Imperial/Regal 6 Single-Depth Tub Recessed Middle Prep-Procedure Tables

## 3 Drawers + Knee Space + Cupboard, Door Hinged Right 6 Single-Depth Tub, Faucet Right

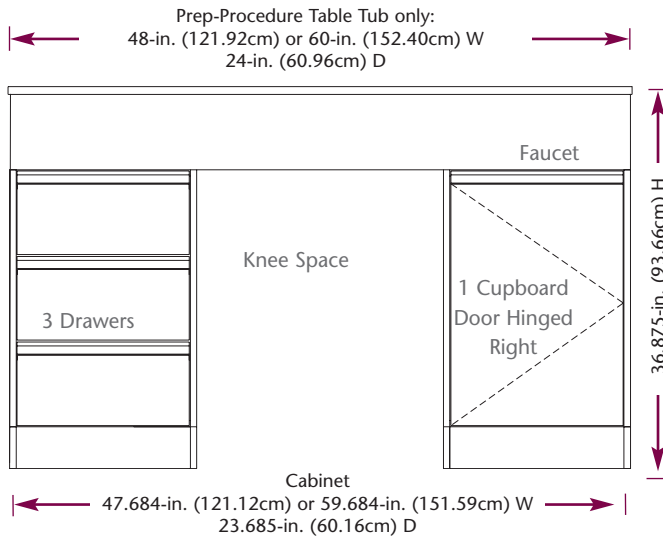

P/N	TOP STYLE	COLOR	
		CABINET	TOP
<b>IMPERIAL LAMINATED CABINET</b>			
48-in. (121.92cm) wide Laminated Cabinet			
L15AA04U0B1E0A3	Tub	-	† N/A
L15HB04U0B1E0A3	SS Abutted Top & Tub	-	† N/A
L15HH04U0B1E0A3	Laminated Abutted Top & Tub	-	† -
60-in. (152.40cm) wide Laminated Cabinet			
L15AA04U0B1E0A5	Tub	-	† N/A
L15HB04U0B1E0A5	SS Abutted Top & Tub	-	† N/A
L15HH04U0B1E0A5	Laminated Abutted Top & Tub	-	† -
<b>REGAL STAINLESS STEEL CABINET</b>			
48-in. (121.92cm) wide Stainless Steel Cabinet			
Y15AA04U0B1E0A3	Tub	N/A	N/A
Y15HB04U0B1E0A3	SS Abutted Top & Tub	N/A	N/A
Y15HH04U0B1E0A3	Laminated Abutted Top & Tub	N/A	-
60-in. (152.40cm) wide Stainless Steel Cabinet			
Y15AA04U0B1E0A5	Tub	N/A	N/A
Y15HB04U0B1E0A5	SS Abutted Top & Tub	N/A	N/A
Y15HH04U0B1E0A5	Laminated Abutted Top & Tub	N/A	-

## Cupboard, Door Hinged Left + Knee Space + 3 Drawers 6 Single-Depth Tub, Faucet Left

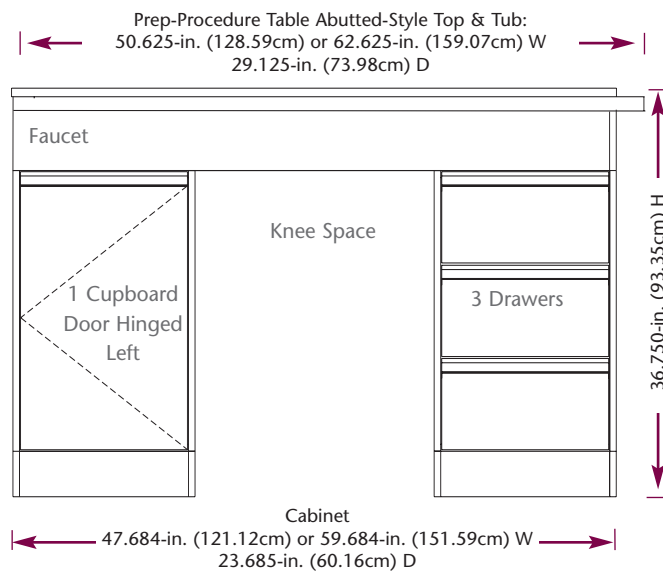

P/N	TOP STYLE	COLOR	
		CABINET	TOP
<b>IMPERIAL LAMINATED CABINET</b>			
48-in. (121.92cm) wide Laminated Cabinet			
L15AA03D0B1U0A3	Tub	-	† N/A
L15HB03D0B1U0A3	SS Abutted Top & Tub	-	† N/A
L15HH03D0B1U0A3	Laminated Abutted Top & Tub	-	† -
60-in. (152.40cm) wide Laminated Cabinet			
L15AA03D0B1U0A5	Tub	-	† N/A
L15HB03D0B1U0A5	SS Abutted Top & Tub	-	† N/A
L15HH03D0B1U0A5	Laminated Abutted Top & Tub	-	† -
<b>REGAL STAINLESS STEEL CABINET</b>			
48-in. (121.92cm) wide Stainless Steel Cabinet			
Y15AA03D0B1U0A3	Tub	N/A	N/A
Y15HB03D0B1U0A3	SS Abutted Top & Tub	N/A	N/A
Y15HH03D0B1U0A3	Laminated Abutted Top & Tub	N/A	-
60-in. (152.40cm) wide Stainless Steel Cabinet			
Y15AA03D0B1U0A5	Tub	N/A	N/A
Y15HB03D0B1U0A5	SS Abutted Top & Tub	N/A	N/A
Y15HH03D0B1U0A5	Laminated Abutted Top & Tub	N/A	-

**Important:** These customer order requirements, in addition to other customer order requirements, must be satisfied prior to the beginning of manufacturing lead time:  
†Specify 4-digit Color code. See Color Selections, Section A, pages 1 & 2 for Color Codes.



SSCI laminated products are available in SSCI standard laminates, SSCI optional laminates, or Customer selected laminates.



# Imperial/Regal 6 Single-Depth Tub Recessed Middle Prep-Procedure Tables

P/N	TOP STYLE	COLOR	
		CABINET	TOP
<b>IMPERIAL LAMINATED CABINET</b>			
48-in. (121.92cm) wide Laminated Cabinet			
L15AA04V0B1E0A3	Tub	- - - - †	N/A
L15HB04V0B1E0A3	SS Abutted Top & Tub	- - - - †	N/A
L15HH04V0B1E0A3	Laminated Abutted Top & Tub	- - - - †	- - - - †
60-in. (152.40cm) wide Laminated Cabinet			
L15AA04V0B1E0A5	Tub	- - - - †	N/A
L15HB04V0B1E0A5	SS Abutted Top & Tub	- - - - †	N/A
L15HH04V0B1E0A5	Laminated Abutted Top & Tub	- - - - †	- - - - †
<b>REGAL STAINLESS STEEL CABINET</b>			
48-in. (121.92cm) wide Stainless Steel Cabinet			
Y15AA04V0B1E0A3	Tub	N/A	N/A
Y15HB04V0B1E0A3	SS Abutted Top & Tub	N/A	N/A
Y15HH04V0B1E0A3	Laminated Abutted Top & Tub	N/A	- - - - †
60-in. (152.40cm) wide Stainless Steel Cabinet			
Y15AA04V0B1E0A5	Tub	N/A	N/A
Y15HB04V0B1E0A5	SS Abutted Top & Tub	N/A	N/A
Y15HH04V0B1E0A5	Laminated Abutted Top & Tub	N/A	- - - - †

## 4 Drawers + Knee Space + Cupboard, Door Hinged Right 6 Single-Depth Tub, Faucet Right

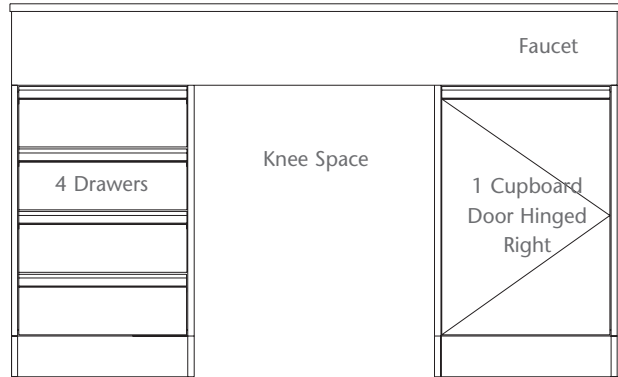

P/N	TOP STYLE	COLOR	
		CABINET	TOP
<b>IMPERIAL LAMINATED CABINET</b>			
48-in. (121.92cm) wide Laminated Cabinet			
L15AA03D0B1V0A3	Tub	- - - - †	N/A
L15HB03D0B1V0A3	SS Abutted Top & Tub	- - - - †	N/A
L15HH03D0B1V0A3	Laminated Abutted Top & Tub	- - - - †	- - - - †
60-in. (152.40cm) wide Laminated Cabinet			
L15AA03D0B1V0A5	Tub	- - - - †	N/A
L15HB03D0B1V0A5	SS Abutted Top & Tub	- - - - †	N/A
L15HH03D0B1V0A5	Laminated Abutted Top & Tub	- - - - †	- - - - †
<b>REGAL STAINLESS STEEL CABINET</b>			
48-in. (121.92cm) wide Stainless Steel Cabinet			
Y15AA03D0B1V0A3	Tub	N/A	N/A
Y15HB03D0B1V0A3	SS Abutted Top & Tub	N/A	N/A
Y15HH03D0B1V0A3	Laminated Abutted Top & Tub	N/A	- - - - †
60-in. (152.40cm) wide Stainless Steel Cabinet			
Y15AA03D0B1V0A5	Tub	N/A	N/A
Y15HB03D0B1V0A5	SS Abutted Top & Tub	N/A	N/A
Y15HH03D0B1V0A5	Laminated Abutted Top & Tub	N/A	- - - - †

## Cupboard, Door Hinged Left + Knee Space + 4 Drawers 6 Single-Depth Tub, Faucet Left

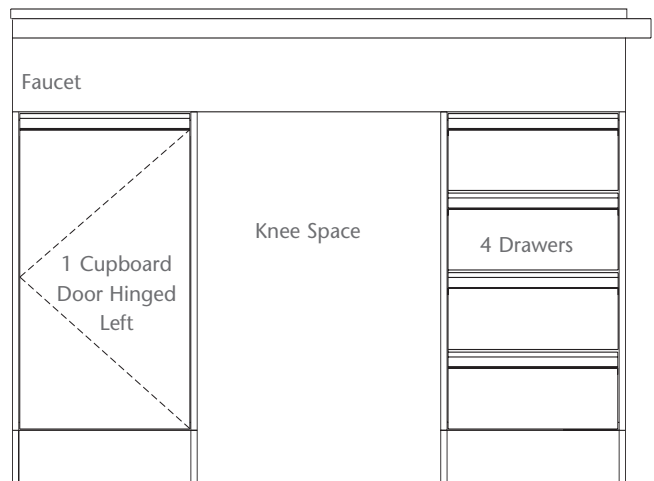

**Important:** These customer order requirements, in addition to other customer order requirements, must be satisfied prior to the beginning of manufacturing lead time:  
 †Specify 4-digit Color code. See Color Selections, Section A, pages 1 & 2 for Color Codes.



SSCI laminated products are available in SSCI standard laminates, SSCI optional laminates, or Customer selected laminates.

# Imperial/Regal 6 Single-Depth Tub Recessed Middle Prep-Procedure Tables

## Cupboard, Door Hinged Left + Knee Space + Cupboard, Door Hinged Right 6 Single-Depth Tub, Faucet Right

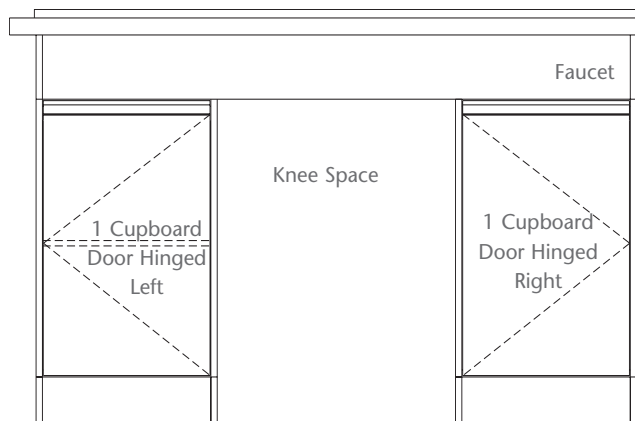

P/N	TOP STYLE	COLOR	
		CABINET	TOP
<b>IMPERIAL LAMINATED CABINET</b>			
48-in. (121.92cm) wide Laminated Cabinet			
L15AA04D0B1E0A3	Tub	- - - - †	N/A
L15HB04D0B1E0A3	SS Abutted Top & Tub	- - - - †	N/A
L15HH04D0B1E0A3	Laminated Abutted Top & Tub	- - - - †	- - - - †
60-in. (152.40cm) wide Laminated Cabinet			
L15AA04D0B1E0A5	Tub	- - - - †	N/A
L15HB04D0B1E0A5	SS Abutted Top & Tub	- - - - †	N/A
L15HH04D0B1E0A5	Laminated Abutted Top & Tub	- - - - †	- - - - †
<b>REGAL STAINLESS STEEL CABINET</b>			
48-in. (121.92cm) wide Stainless Steel Cabinet			
Y15AA04D0B1E0A3	Tub	N/A	N/A
Y15HB04D0B1E0A3	SS Abutted Top & Tub	N/A	N/A
Y15HH04D0B1E0A3	Laminated Abutted Top & Tub	N/A	- - - - †
60-in. (152.40cm) wide Stainless Steel Cabinet			
Y15AA04D0B1E0A5	Tub	N/A	N/A
Y15HB04D0B1E0A5	SS Abutted Top & Tub	N/A	N/A
Y15HH04D0B1E0A5	Laminated Abutted Top & Tub	N/A	- - - - †

## Cupboard, Door Hinged Left + Knee Space + Cupboard, Door Hinged Right 6 Single-Depth Tub, Faucet Left

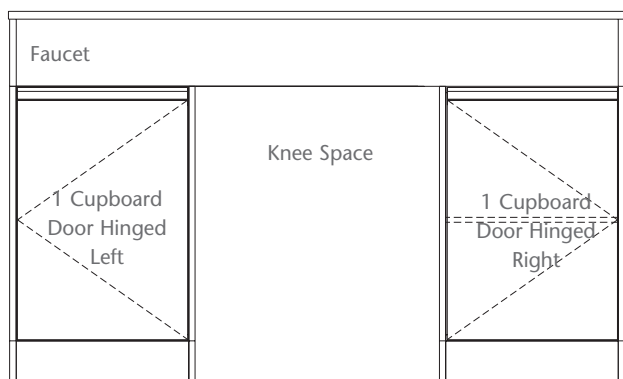

P/N	TOP STYLE	COLOR	
		CABINET	TOP
<b>IMPERIAL LAMINATED CABINET</b>			
48-in. (121.92cm) wide Laminated Cabinet			
L15AA03D0B1E0A3	Tub	- - - - †	N/A
L15HB03D0B1E0A3	SS Abutted Top & Tub	- - - - †	N/A
L15HH03D0B1E0A3	Laminated Abutted Top & Tub	- - - - †	- - - - †
60-in. (152.40cm) wide Laminated Cabinet			
L15AA03D0B1E0A5	Tub	- - - - †	N/A
L15HB03D0B1E0A5	SS Abutted Top & Tub	- - - - †	N/A
L15HH03D0B1E0A5	Laminated Abutted Top & Tub	- - - - †	- - - - †
<b>REGAL STAINLESS STEEL CABINET</b>			
48-in. (121.92cm) wide Stainless Steel Cabinet			
Y15AA03D0B1E0A3	Tub	N/A	N/A
Y15HB03D0B1E0A3	SS Abutted Top & Tub	N/A	N/A
Y15HH03D0B1E0A3	Laminated Abutted Top & Tub	N/A	- - - - †
60-in. (152.40cm) wide Stainless Steel Cabinet			
Y15AA03D0B1E0A5	Tub	N/A	N/A
Y15HB03D0B1E0A5	SS Abutted Top & Tub	N/A	N/A
Y15HH03D0B1E0A5	Laminated Abutted Top & Tub	N/A	- - - - †

**Important:** These customer order requirements, in addition to other customer order requirements, must be satisfied prior to the beginning of manufacturing lead time:

†Specify 4-digit Color code. See Color Selections, Section A, pages 1 & 2 for Color Codes.



SSCI laminated products are available in SSCI standard laminates, SSCI optional laminates, or Customer selected laminates.

# Imperial/Regal 6 Single-Depth Tub Prep-Procedure Tables

**Imperial 6 Prep-Procedure Table**  
**6 Single-Depth Tub and Removable Prep Rack,**  
**Cupboard, Door Hinged Left + Cupboard, Door Hinged Left + 4 Drawers**  
**Faucet, on Left; sold separately, see Faucets Section.**



## Imperial/Regal 6

### Prep-Procedure Tables

All Full-cabinet Prep-Procedure Tables include our 6 Single-depth Tub and removable Prep Rack. The cabinet is divided into 3 sections; offering three compartments for drawers or cupboards to give you the extra storage space you need to keep all your treatment supplies close at hand. We offer these Tables with your choice of a durable, top-quality, high-pressure laminated **Imperial** Cabinet, or an all stainless steel **Regal** Cabinet for unsurpassed durability. **Imperial** laminated Tables are available in SSCI Standard colors, or SSCI optional colors or choose from a spectrum of customer-selected colors to blend with your décor. Tables are available with tub only or with a countertop and tub. Choose either stainless steel or laminated countertops.



**Regal 6 Prep-Procedure Table**  
**6 Single-Depth Tub and Removable Prep Rack,**  
**Cupboard, Door Hinged Left +3 Drawers + 3 Drawers,**  
**Faucet, on Right; sold separately, see Faucets Section.**

# Imperial/Regal 6 Single-Depth Tub Prep-Procedure Tables

## Cupboard, Door Hinged Left + Cupboard, Door Hinged Left + 4 Drawers 6 Single-Depth Tub, Faucet Left

Prep-Procedure Table Tub only:  
48-in. (121.92cm) or 60-in. (152.40cm) W  
24-in. (60.96cm) D

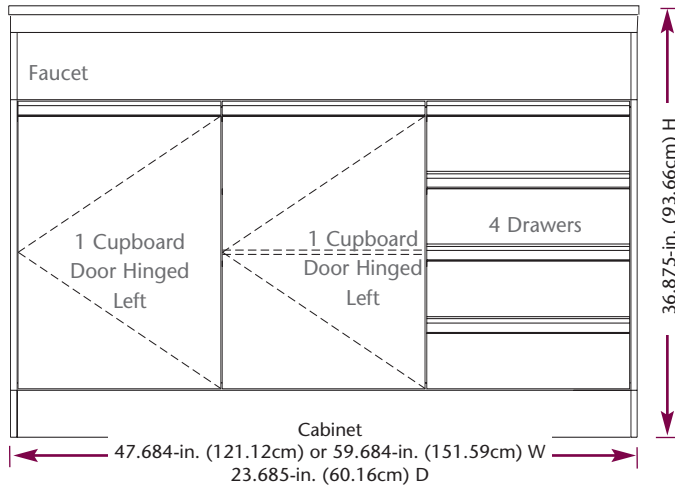

P/N	TOP STYLE	COLOR	
		CABINET	TOP
<b>IMPERIAL LAMINATED CABINET</b>			
48-in. (121.92cm) wide Laminated Cabinet			
L13AA03D0D0V0A3	Tub	-	† N/A
L13HB03D0D0V0A3	SS Abutted Top & Tub	-	† N/A
L13HH03D0D0V0A3	Laminated Abutted Top & Tub	-	† -
60-in. (152.40cm) wide Laminated Cabinet			
L13AA03D0D0V0A5	Tub	-	† N/A
L13HB03D0D0V0A5	SS Abutted Top & Tub	-	† N/A
L13HH03D0D0V0A5	Laminated Abutted Top & Tub	-	† -
<b>REGAL STAINLESS STEEL CABINET</b>			
48-in. (121.92cm) wide Stainless Steel Cabinet			
Y13AA03D0D0V0A3	Tub	N/A	N/A
Y13HB03D0D0V0A3	SS Abutted Top & Tub	N/A	N/A
Y13HH03D0D0V0A3	Laminated Abutted Top & Tub	N/A	-
60-in. (152.40cm) wide Stainless Steel Cabinet			
Y13AA03D0D0V0A5	Tub	N/A	N/A
Y13HB03D0D0V0A5	SS Abutted Top & Tub	N/A	N/A
Y13HH03D0D0V0A5	Laminated Abutted Top & Tub	N/A	-

## 4 Drawers + Cupboard, Door Hinged Right + Cupboard, Door Hinged Right 6 Single-Depth Tub, Faucet Right

Prep-Procedure Table Abutted-Style Top & Tub:  
50.625-in. (128.59cm) or 62.625-in. (159.07cm) W  
29.125-in. (73.98cm) D

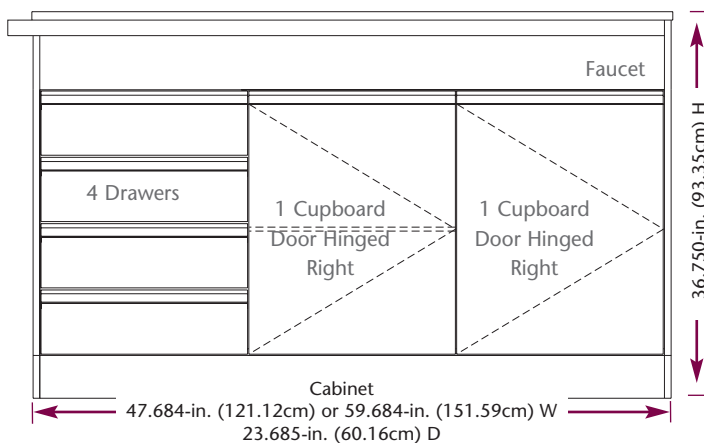

P/N	TOP STYLE	COLOR	
		CABINET	TOP
<b>IMPERIAL LAMINATED CABINET</b>			
48-in. (121.92cm) wide Laminated Cabinet			
L13AA04V0E0E0A3	Tub	-	† N/A
L13HB04V0E0E0A3	SS Abutted Top & Tub	-	† N/A
L13HH04V0E0E0A3	Laminated Abutted Top & Tub	-	† -
60-in. (152.40cm) wide Laminated Cabinet			
L13AA04V0E0E0A5	Tub	-	† N/A
L13HB04V0E0E0A5	SS Abutted Top & Tub	-	† N/A
L13HH04V0E0E0A5	Laminated Abutted Top & Tub	-	† -
<b>REGAL STAINLESS STEEL CABINET</b>			
48-in. (121.92cm) wide Stainless Steel Cabinet			
Y13AA04V0E0E0A3	Tub	N/A	N/A
Y13HB04V0E0E0A3	SS Abutted Top & Tub	N/A	N/A
Y13HH04V0E0E0A3	Laminated Abutted Top & Tub	N/A	-
60-in. (152.40cm) wide Stainless Steel Cabinet			
Y13AA04V0E0E0A5	Tub	N/A	N/A
Y13HB04V0E0E0A5	SS Abutted Top & Tub	N/A	N/A
Y13HH04V0E0E0A5	Laminated Abutted Top & Tub	N/A	-

**Important:** These customer order requirements, in addition to other customer order requirements, must be satisfied prior to the beginning of manufacturing lead time:

† Specify 4-digit Color code. See Color Selections, Section A, pages 1 & 2 for Color Codes.



SSCI laminated products are available in SSCI standard laminates, SSCI optional laminates, or Customer selected laminates.

# Imperial/Regal 6 Single-Depth Tub Prep-Procedure Tables

P/N	TOP STYLE	COLOR	
		CABINET	TOP
<b>IMPERIAL LAMINATED CABINET</b>			
48-in. (121.92cm) wide Laminated Cabinet			
L13AA03D0D0U0A3	Tub	- - - - †	N/A
L13HB03D0D0U0A3	SS Abutted Top & Tub	- - - - †	N/A
L13HH03D0D0U0A3	Laminated Abutted Top & Tub	- - - - †	- - - - †
60-in. (152.40cm) wide Laminated Cabinet			
L13AA03D0D0U0A5	Tub	- - - - †	N/A
L13HB03D0D0U0A5	SS Abutted Top & Tub	- - - - †	N/A
L13HH03D0D0U0A5	Laminated Abutted Top & Tub	- - - - †	- - - - †
<b>REGAL STAINLESS STEEL CABINET</b>			
48-in. (121.92cm) wide Stainless Steel Cabinet			
Y13AA03D0D0U0A3	Tub	N/A	N/A
Y13HB03D0D0U0A3	SS Abutted Top & Tub	N/A	N/A
Y13HH03D0D0U0A3	Laminated Abutted Top & Tub	N/A	- - - - †
60-in. (152.40cm) wide Stainless Steel Cabinet			
Y13AA03D0D0U0A5	Tub	N/A	N/A
Y13HB03D0D0U0A5	SS Abutted Top & Tub	N/A	N/A
Y13HH03D0D0U0A5	Laminated Abutted Top & Tub	N/A	- - - - †

## Cupboard, Door Hinged Left + Cupboard, Door Hinged Left + 3 Drawers 6 Single-Depth Tub, Faucet Left

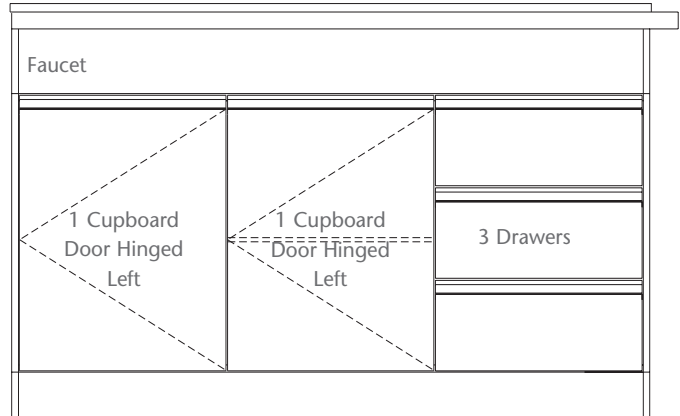

P/N	TOP STYLE	COLOR	
		CABINET	TOP
<b>IMPERIAL LAMINATED CABINET</b>			
48-in. (121.92cm) wide Laminated Cabinet			
L13AA04U0E0E0A3	Tub	- - - - †	N/A
L13HB04U0E0E0A3	SS Abutted Top & Tub	- - - - †	N/A
L13HH04U0E0E0A3	Laminated Abutted Top & Tub	- - - - †	- - - - †
60-in. (152.40cm) wide Laminated Cabinet			
L13AA04U0E0E0A5	Tub	- - - - †	N/A
L13HB04U0E0E0A5	SS Abutted Top & Tub	- - - - †	N/A
L13HH04U0E0E0A5	Laminated Abutted Top & Tub	- - - - †	- - - - †
<b>REGAL STAINLESS STEEL CABINET</b>			
48-in. (121.92cm) wide Stainless Steel Cabinet			
Y13AA04U0E0E0A3	Tub	N/A	N/A
Y13HB04U0E0E0A3	SS Abutted Top & Tub	N/A	N/A
Y13HH04U0E0E0A3	Laminated Abutted Top & Tub	N/A	- - - - †
60-in. (152.40cm) wide Stainless Steel Cabinet			
Y13AA04U0E0E0A5	Tub	N/A	N/A
Y13HB04U0E0E0A5	SS Abutted Top & Tub	N/A	N/A
Y13HH04U0E0E0A5	Laminated Abutted Top & Tub	N/A	- - - - †

## 3 Drawers + Cupboard, Door Hinged Right + Cupboard, Door Hinged Right 6 Single-Depth Tub, Faucet Right

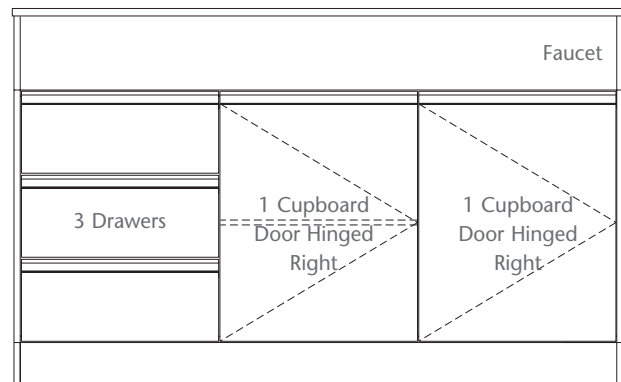

**Important:** These customer order requirements, in addition to other customer order requirements, must be satisfied prior to the beginning of manufacturing lead time:

†Specify 4-digit Color code. See Color Selections, Section A, pages 1 & 2 for Color Codes.



SSCI laminated products are available in SSCI standard laminates, SSCI optional laminates, or Customer selected laminates.

**For Product Information Call TOLL-FREE 1-800-323-7366 • (847) 537-9320 • Fax (847) 537-9061**

**Hours: 8:30am - 5:00pm CST Monday - Friday**

Visit our website at: [www.suburbansurgical.com](http://www.suburbansurgical.com)

# Imperial/Regal 6 Single-Depth Tub Prep-Procedure Tables

## Cupboard, Door Hinged Left + 3 + 3 Drawers 6 Single-Depth Tub, Faucet Left

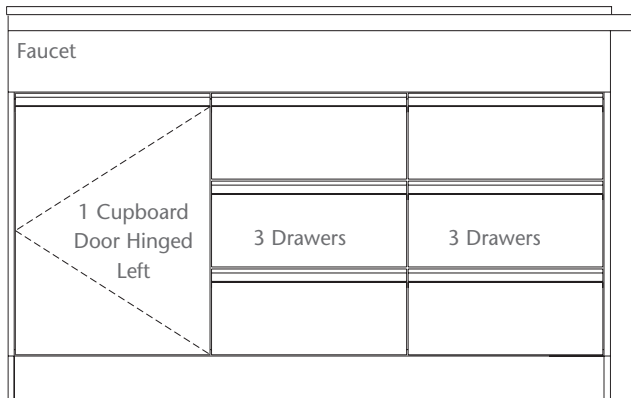

P/N	TOP STYLE	COLOR	
		CABINET	TOP
<b>IMPERIAL LAMINATED CABINET</b>			
48-in. (121.92cm) wide Laminated Cabinet			
L13AA03D0U0U0A3	Tub	- - - - †	N/A
L13HB03D0U0U0A3	SS Abutted Top & Tub	- - - - †	N/A
L13HH03D0U0U0A3	Laminated Abutted Top & Tub	- - - - †	- - - - †
60-in. (152.40cm) wide Laminated Cabinet			
L13AA03D0U0U0A5	Tub	- - - - †	N/A
L13HB03D0U0U0A5	SS Abutted Top & Tub	- - - - †	N/A
L13HH03D0U0U0A5	Laminated Abutted Top & Tub	- - - - †	- - - - †
<b>REGAL STAINLESS STEEL CABINET</b>			
48-in. (121.92cm) wide Stainless Steel Cabinet			
Y13AA03D0U0U0A3	Tub	N/A	N/A
Y13HB03D0U0U0A3	SS Abutted Top & Tub	N/A	N/A
Y13HH03D0U0U0A3	Laminated Abutted Top & Tub	N/A	- - - - †
60-in. (152.40cm) wide Stainless Steel Cabinet			
Y13AA03D0U0U0A5	Tub	N/A	N/A
Y13HB03D0U0U0A5	SS Abutted Top & Tub	N/A	N/A
Y13HH03D0U0U0A5	Laminated Abutted Top & Tub	N/A	- - - - †

## 3 + 3 Drawers + Cupboard, Door Hinged Right 6 Single-Depth Tub, Faucet Right

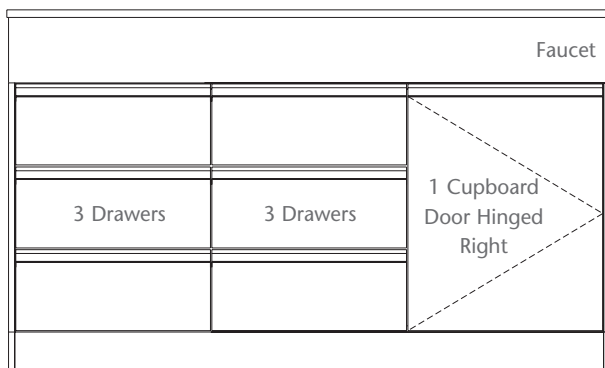

P/N	TOP STYLE	COLOR	
		CABINET	TOP
<b>IMPERIAL LAMINATED CABINET</b>			
48-in. (121.92cm) wide Laminated Cabinet			
L13AA04U0U0E0A3	Tub	- - - - †	N/A
L13HB04U0U0E0A3	SS Abutted Top & Tub	- - - - †	N/A
L13HH04U0U0E0A3	Laminated Abutted Top & Tub	- - - - †	- - - - †
60-in. (152.40cm) wide Laminated Cabinet			
L13AA04U0U0E0A5	Tub	- - - - †	N/A
L13HB04U0U0E0A5	SS Abutted Top & Tub	- - - - †	N/A
L13HH04U0U0E0A5	Laminated Abutted Top & Tub	- - - - †	- - - - †
<b>REGAL STAINLESS STEEL CABINET</b>			
48-in. (121.92cm) wide Stainless Steel Cabinet			
Y13AA04U0U0E0A3	Tub	N/A	N/A
Y13HB04U0U0E0A3	SS Abutted Top & Tub	N/A	N/A
Y13HH04U0U0E0A3	Laminated Abutted Top & Tub	N/A	- - - - †
60-in. (152.40cm) wide Stainless Steel Cabinet			
Y13AA04U0U0E0A5	Tub	N/A	N/A
Y13HB04U0U0E0A5	SS Abutted Top & Tub	N/A	N/A
Y13HH04U0U0E0A5	Laminated Abutted Top & Tub	N/A	- - - - †

**Important:** These customer order requirements, in addition to other customer order requirements, must be satisfied prior to the beginning of manufacturing lead time:

†Specify 4-digit Color code. See Color Selections, Section A, pages 1 & 2 for Color Codes.



SSCI laminated products are available in SSCI standard laminates, SSCI optional laminates, or Customer selected laminates.

# Imperial/Regal 6 Single-Depth Tub Prep-Procedure Tables

## Cupboard, Door Hinged Left + 4 Drawers 6 Single-Depth Tub, Faucet Left

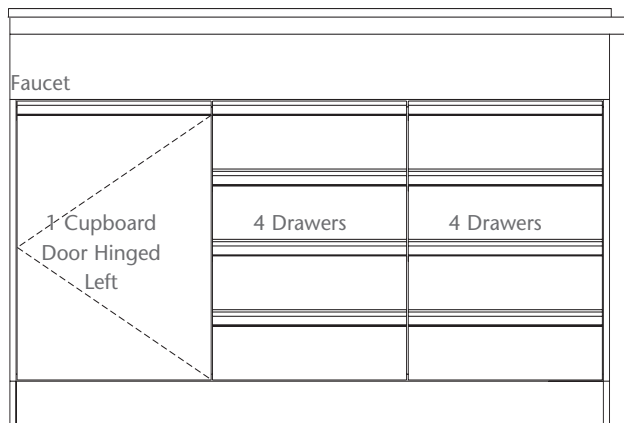

P/N	TOP STYLE	COLOR	
		CABINET	TOP
<b>IMPERIAL LAMINATED CABINET</b>			
48-in. (121.92cm) wide Laminated Cabinet			
L13AA03D0V0V0A3	Tub	- - - - †	N/A
L13HB03D0V0V0A3	SS Abutted Top & Tub	- - - - †	N/A
L13HH03D0V0V0A3	Laminated Abutted Top & Tub	- - - - †	- - - - †
60-in. (152.40cm) wide Laminated Cabinet			
L13AA03D0V0V0A5	Tub	- - - - †	N/A
L13HB03D0V0V0A5	SS Abutted Top & Tub	- - - - †	N/A
L13HH03D0V0V0A5	Laminated Abutted Top & Tub	- - - - †	- - - - †
<b>REGAL STAINLESS STEEL CABINET</b>			
48-in. (121.92cm) wide Stainless Steel Cabinet			
Y13AA03D0V0V0A3	Tub	N/A	N/A
Y13HB03D0V0V0A3	SS Abutted Top & Tub	N/A	N/A
Y13HH03D0V0V0A3	Laminated Abutted Top & Tub	N/A	- - - - †
60-in. (152.40cm) wide Stainless Steel Cabinet			
Y13AA03D0V0V0A5	Tub	N/A	N/A
Y13HB03D0V0V0A5	SS Abutted Top & Tub	N/A	N/A
Y13HH03D0V0V0A5	Laminated Abutted Top & Tub	N/A	- - - - †

## 4 + 4 Drawers + Cupboard, Door Hinged Right 6 Single-Depth Tub, Faucet Right

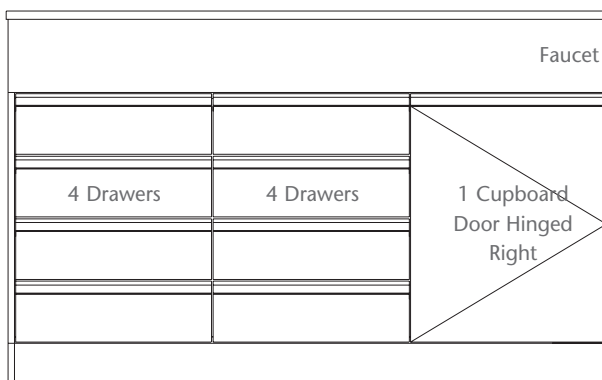

P/N	TOP STYLE	COLOR	
		CABINET	TOP
<b>IMPERIAL LAMINATED CABINET</b>			
48-in. (121.92cm) wide Laminated Cabinet			
L13AA04V0V0E0A3	Tub	- - - - †	N/A
L13HB04V0V0E0A3	SS Abutted Top & Tub	- - - - †	N/A
L13HH04V0V0E0A3	Laminated Abutted Top & Tub	- - - - †	- - - - †
60-in. (152.40cm) wide Laminated Cabinet			
L13AA04V0V0E0A5	Tub	- - - - †	N/A
L13HB04V0V0E0A5	SS Abutted Top & Tub	- - - - †	N/A
L13HH04V0V0E0A5	Laminated Abutted Top & Tub	- - - - †	- - - - †
<b>REGAL STAINLESS STEEL CABINET</b>			
48-in. (121.92cm) wide Stainless Steel Cabinet			
Y13AA04V0V0E0A3	Tub	N/A	N/A
Y13HB04V0V0E0A3	SS Abutted Top & Tub	N/A	N/A
Y13HH04V0V0E0A3	Laminated Abutted Top & Tub	N/A	- - - - †
60-in. (152.40cm) wide Stainless Steel Cabinet			
Y13AA04V0V0E0A5	Tub	N/A	N/A
Y13HB04V0V0E0A5	SS Abutted Top & Tub	N/A	N/A
Y13HH04V0V0E0A5	Laminated Abutted Top & Tub	N/A	- - - - †

**Important:** These customer order requirements, in addition to other customer order requirements, must be satisfied prior to the beginning of manufacturing lead time:  
 †Specify 4-digit Color code. See Color Selections, Section A, pages 1 & 2 for Color Codes.



SSCI laminated products are available in SSCI standard laminates, SSCI optional laminates, or Customer selected laminates.

# Imperial/Regal 6 Single-Depth Tub Prep-Procedure Tables

## Cupboard, Pair of Hinged Doors + 3 Drawers 6 Single-Depth Tub, Faucet Left

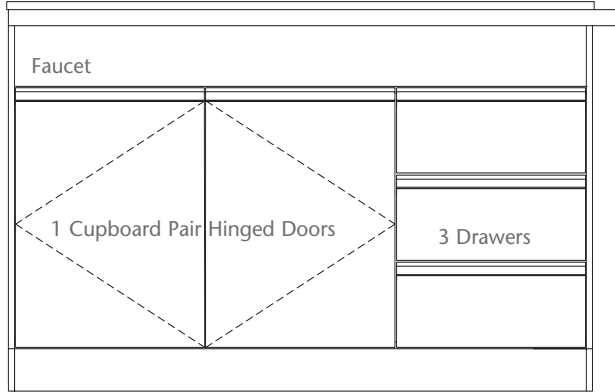

P/N	TOP STYLE	COLOR	
		CABINET	TOP
<b>IMPERIAL LAMINATED CABINET</b>			
<b>48-in. (121.92cm) wide Laminated Cabinet</b>			
L13AA03G0A0U0A3	Tub	- - - - †	N/A
L13HB03G0A0U0A3	SS Abutted Top & Tub	- - - - †	N/A
L13HH03G0A0U0A3	Laminated Abutted Top & Tub	- - - - †	- - - - †
<b>60-in. (152.40cm) wide Laminated Cabinet</b>			
L13AA03G0A0U0A5	Tub	- - - - †	N/A
L13HB03G0A0U0A5	SS Abutted Top & Tub	- - - - †	N/A
L13HH03G0A0U0A5	Laminated Abutted Top & Tub	- - - - †	- - - - †
<b>REGAL STAINLESS STEEL CABINET</b>			
<b>48-in. (121.92cm) wide Stainless Steel Cabinet</b>			
Y13AA03G0A0U0A3	Tub	N/A	N/A
Y13HB03G0A0U0A3	SS Abutted Top & Tub	N/A	N/A
Y13HH03G0A0U0A3	Laminated Abutted Top & Tub	N/A	- - - - †
<b>60-in. (152.40cm) wide Stainless Steel Cabinet</b>			
Y13AA03G0A0U0A5	Tub	N/A	N/A
Y13HB03G0A0U0A5	SS Abutted Top & Tub	N/A	N/A
Y13HH03G0A0U0A5	Laminated Abutted Top & Tub	N/A	- - - - †

## 3 Drawers + Cupboard, Pair of Hinged Doors 6 Single-Depth Tub, Faucet Right

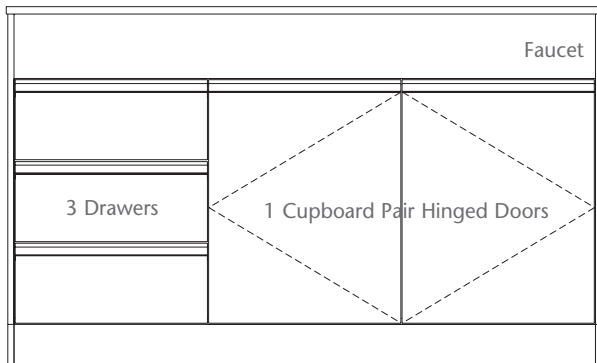

P/N	TOP STYLE	COLOR	
		CABINET	TOP
<b>IMPERIAL LAMINATED CABINET</b>			
<b>48-in. (121.92cm) wide Laminated Cabinet</b>			
L13AA04U0A0G0A3	Tub	- - - - †	N/A
L13HB04U0A0G0A3	SS Abutted Top & Tub	- - - - †	N/A
L13HH04U0A0G0A3	Laminated Abutted Top & Tub	- - - - †	- - - - †
<b>60-in. (152.40cm) wide Laminated Cabinet</b>			
L13AA04U0A0G0A5	Tub	- - - - †	N/A
L13HB04U0A0G0A5	SS Abutted Top & Tub	- - - - †	N/A
L13HH04U0A0G0A5	Laminated Abutted Top & Tub	- - - - †	- - - - †
<b>REGAL STAINLESS STEEL CABINET</b>			
<b>48-in. (121.92cm) wide Stainless Steel Cabinet</b>			
Y13AA04U0A0G0A3	Tub	N/A	N/A
Y13HB04U0A0G0A3	SS Abutted Top & Tub	N/A	N/A
Y13HH04U0A0G0A3	Laminated Abutted Top & Tub	N/A	- - - - †
<b>60-in. (152.40cm) wide Stainless Steel Cabinet</b>			
Y13AA04U0A0G0A5	Tub	N/A	N/A
Y13HB04U0A0G0A5	SS Abutted Top & Tub	N/A	N/A
Y13HH04U0A0G0A5	Laminated Abutted Top & Tub	N/A	- - - - †

**Important:** These customer order requirements, in addition to other customer order requirements, must be satisfied prior to the beginning of manufacturing lead time:

†Specify 4-digit Color code. See Color Selections, Section A, pages 1 & 2 for Color Codes.



SSCI laminated products are available in SSCI standard laminates, SSCI optional laminates, or Customer selected laminates.



# Imperial/Regal 6 Single-Depth Tub Prep-Procedure Tables

## Cupboard, Pair of Hinged Doors + 4 Drawers 6 Single-Depth Tub, Faucet Left

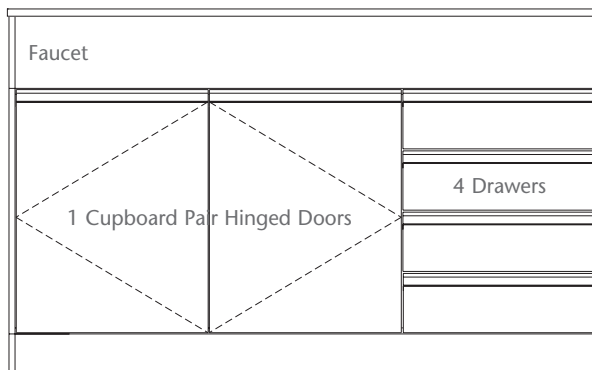

P/N	TOP STYLE	COLOR	
		CABINET	TOP
<b>IMPERIAL LAMINATED CABINET</b>			
48-in. (121.92cm) wide Laminated Cabinet			
L13AA03G0A0V0A3	Tub	- - - - †	N/A
L13HB03G0A0V0A3	SS Abutted Top & Tub	- - - - †	N/A
L13HH03G0A0V0A3	Laminated Abutted Top & Tub	- - - - †	- - - - †
60-in. (152.40cm) wide Laminated Cabinet			
L13AA03G0A0V0A5	Tub	- - - - †	N/A
L13HB03G0A0V0A5	SS Abutted Top & Tub	- - - - †	N/A
L13HH03G0A0V0A5	Laminated Abutted Top & Tub	- - - - †	- - - - †
<b>REGAL STAINLESS STEEL CABINET</b>			
48-in. (121.92cm) wide Stainless Steel Cabinet			
Y13AA03G0A0V0A3	Tub	N/A	N/A
Y13HB03G0A0V0A3	SS Abutted Top & Tub	N/A	N/A
Y13HH03G0A0V0A3	Laminated Abutted Top & Tub	N/A	- - - - †
60-in. (152.40cm) wide			
Y13AA03G0A0V0A5	Tub Stainless Steel Cabinet	N/A	N/A
Y13HB03G0A0V0A5	SS Abutted Top & Tub	N/A	N/A
Y13HH03G0A0V0A5	Laminated Abutted Top & Tub	N/A	- - - - †

## 4 Drawers + Cupboard, Pair of Hinged Doors 6 Single-Depth Tub, Faucet Right

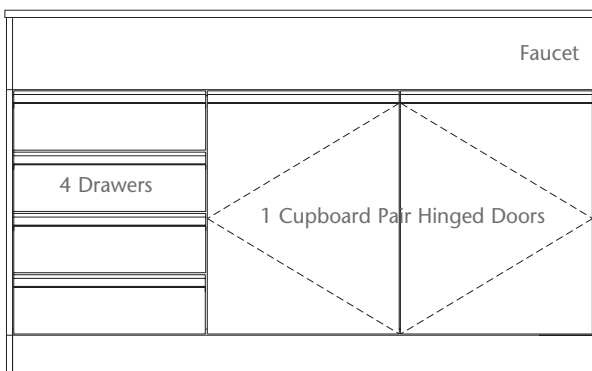

P/N	TOP STYLE	COLOR	
		CABINET	TOP
<b>IMPERIAL LAMINATED CABINET</b>			
48-in. (121.92cm) wide Laminated Cabinet			
L13AA04V0A0G0A3	Tub	- - - - †	N/A
L13HB04V0A0G0A3	SS Abutted Top & Tub	- - - - †	N/A
L13HH04V0A0G0A3	Laminated Abutted Top & Tub	- - - - †	- - - - †
60-in. (152.40cm) wide Laminated Cabinet			
L13AA04V0A0G0A5	Tub	- - - - †	N/A
L13HB04V0A0G0A5	SS Abutted Top & Tub	- - - - †	N/A
L13HH04V0A0G0A5	Laminated Abutted Top & Tub	- - - - †	- - - - †
<b>REGAL STAINLESS STEEL CABINET</b>			
48-in. (121.92cm) wide Stainless Steel Cabinet			
Y13AA04V0A0G0A3	Tub	N/A	N/A
Y13HB04V0A0G0A3	SS Abutted Top & Tub	N/A	N/A
Y13HH04V0A0G0A3	Laminated Abutted Top & Tub	N/A	- - - - †
60-in. (152.40cm) wide Stainless Steel Cabinet			
Y13AA04V0A0G0A5	Tub	N/A	N/A
Y13HB04V0A0G0A5	SS Abutted Top & Tub	N/A	N/A
Y13HH04V0A0G0A5	Laminated Abutted Top & Tub	N/A	- - - - †

**Important:** These customer order requirements, in addition to other customer order requirements, must be satisfied prior to the beginning of manufacturing lead time:

†Specify 4-digit Color code. See Color Selections, Section A, pages 1 & 2 for Color Codes.



SSCI laminated products are available in SSCI standard laminates, SSCI optional laminates, or Customer selected laminates.

# Imperial/Regal 18 Single-Depth Tub Prep-Procedure Tables

**Imperial 18 Prep-Procedure Table,  
18 Single-Depth Tub and Removable Prep Rack,  
Cupboard, Pair of Sliding Doors  
Faucet, on Left; sold separately, see Faucets Section.**



## Imperial/Regal 18 Prep-Procedure Tables

All Full-cabinet Prep-Procedure Tables include our 18 Single-depth tub and removable Prep Rack. The extra-deep tub in our Imperial and Regal 18 Prep-Procedure Tables allows you to add dipping treatments to your list of services. Lower storage cupboard with sliding or hinged doors give you easy access to supplies. We offer these Tables with your choice of a durable, top-quality, high-pressure laminated **Imperial** Cabinet, or an all stainless steel **Regal** Cabinet for unsurpassed durability. **Imperial** laminated Tables are available in SSCI Standard colors, or SSCI optional colors or choose from a spectrum of customer-selected colors to blend with your décor. Tables are available with tub only or with a countertop and tub. Choose either stainless steel or laminated countertops.



**Regal 18 Prep-Procedure Table,  
18 Single-Depth Tub and Removable Prep Rack,  
Cupboard, Pair of Hinged Doors  
Faucet, on Left; sold separately, see Faucets Section.**

# Imperial/Regal 18 Single-Depth Tub Prep-Procedure Tables

## Cupboard, Pair of Sliding Doors 18 Single-Depth Tub, Faucet Left

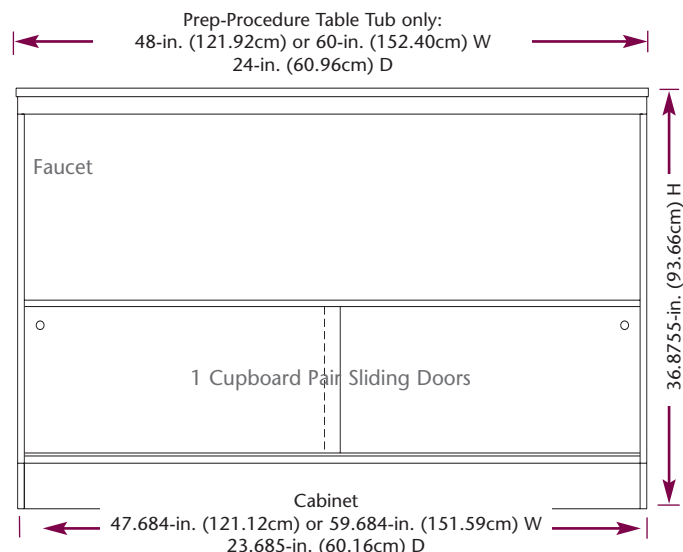

P/N	TOP STYLE	COLOR	
		CABINET	TOP
<b>IMPERIAL LAMINATED CABINET</b>			
<b>48-in. (121.92cm) wide Laminated Cabinet</b>			
L20AA03F0A0A0A3	Tub	- - - - †	N/A
L20HB03F0A0A0A3	SS Abutted Top & Tub	- - - - †	N/A
L20HH03F0A0A0A3	Laminated Abutted Top & Tub	- - - - †	- - - - †
<b>60-in. (152.40cm) wide Laminated Cabinet</b>			
L20AA03F0A0A0A5	Tub	- - - - †	N/A
L20HB03F0A0A0A5	SS Abutted Top & Tub	- - - - †	N/A
L20HH03F0A0A0A5	Laminated Abutted Top & Tub	- - - - †	- - - - †
<b>REGAL STAINLESS STEEL CABINET</b>			
<b>48-in. (121.92cm) wide Stainless Steel Cabinet</b>			
Y20AA03F0A0A0A3	Tub	N/A	N/A
Y20HB03F0A0A0A3	SS Abutted Top & Tub	N/A	N/A
Y20HH03F0A0A0A3	Laminated Abutted Top & Tub	N/A	- - - - †
<b>60-in. (152.40cm) wide Stainless Steel Cabinet</b>			
Y20AA03F0A0A0A5	Tub	N/A	N/A
Y20HB03F0A0A0A5	SS Abutted Top & Tub	N/A	N/A
Y20HH03F0A0A0A5	Laminated Abutted Top & Tub	N/A	- - - - †

## Cupboard, Pair of Sliding Doors 18 Single-Depth Tub, Faucet Right

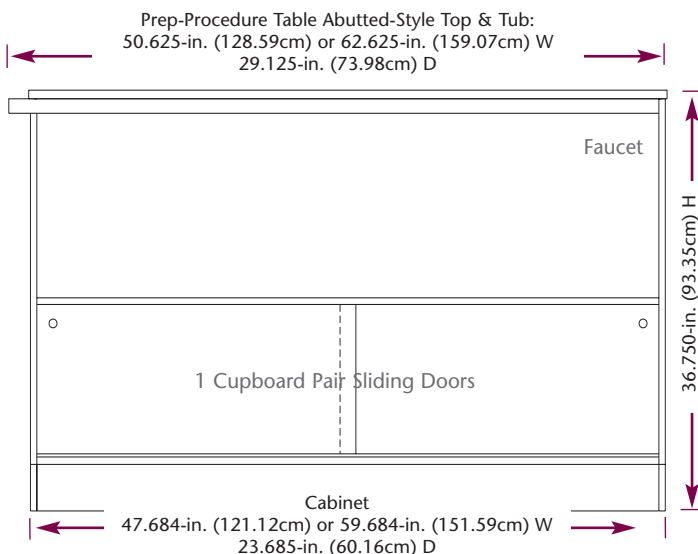

P/N	TOP STYLE	COLOR	
		CABINET	TOP
<b>IMPERIAL LAMINATED CABINET</b>			
<b>48-in. (121.92cm) wide Laminated Cabinet</b>			
L20AA04A0A0F0A3	Tub	- - - - †	N/A
L20HB04A0A0F0A3	SS Abutted Top & tub	- - - - †	N/A
L20HH04A0A0F0A3	Laminated Abutted Top & tub	- - - - †	- - - - †
<b>60-in. (152.40cm) wide Laminated Cabinet</b>			
L20AA04A0A0F0A5	Tub	- - - - †	N/A
L20HB04A0A0F0A5	SS Abutted Top & tub	- - - - †	N/A
L20HH04A0A0F0A5	Laminated Abutted Top & tub	- - - - †	- - - - †
<b>REGAL STAINLESS STEEL CABINET</b>			
<b>48-in. (121.92cm) wide Stainless Steel Cabinet</b>			
Y20AA04A0A0F0A3	Tub	N/A	N/A
Y20HB04A0A0F0A3	SS Abutted Top & tub	N/A	N/A
Y20HH04A0A0F0A3	Laminated Abutted Top & tub	N/A	- - - - †
<b>60-in. (152.40cm) wide Stainless Steel Cabinet</b>			
Y20AA04A0A0F0A5	Tub	N/A	N/A
Y20HB04A0A0F0A5	SS Abutted Top & tub	N/A	N/A
Y20HH04A0A0F0A5	Laminated Abutted Top & tub	N/A	- - - - †

**Important:** These customer order requirements, in addition to other customer order requirements, must be satisfied prior to the beginning of manufacturing lead time:  
†Specify 4-digit Color code. See Color Selections, Section A, pages 1 & 2 for Color Codes.



SSCI laminated products are available in SSCI standard laminates, SSCI optional laminates, or Customer selected laminates.

# Imperial/Regal 18 Single-Depth Tub Prep-Procedure Tables

## Cupboard, Pair of Hinged Doors 18 Single-Depth Tub, Faucet Left

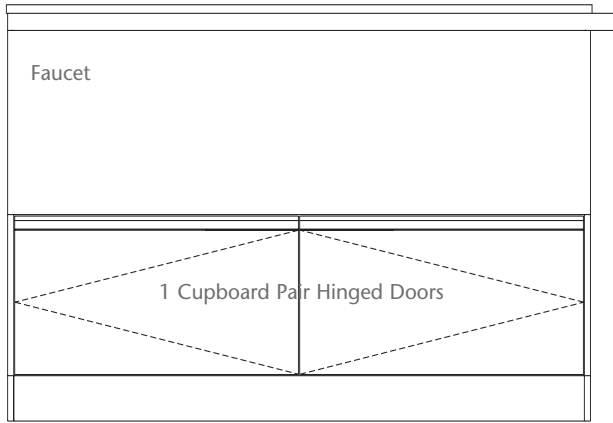

P/N	TOP STYLE	COLOR	
		CABINET	TOP
<b>IMPERIAL LAMINATED CABINET</b>			
<b>48-in. (121.92cm) wide Laminated Cabinet</b>			
L20AA03G0A0A0A3	Tub	- - - - †	N/A
L20HB03G0A0A0A3	SS Abutted Top & Tub	- - - - †	N/A
L20HH03G0A0A0A3	Laminated Abutted Top & Tub	- - - - †	- - - - †
<b>60-in. (152.40cm) wide Laminated Cabinet</b>			
L20AA03G0A0A0A5	Tub	- - - - †	N/A
L20HB03G0A0A0A5	SS Abutted Top & Tub	- - - - †	N/A
L20HH03G0A0A0A5	Laminated Abutted Top & Tub	- - - - †	- - - - †
<b>REGAL STAINLESS STEEL CABINET</b>			
<b>48-in. (121.92cm) wide Stainless Steel Cabinet</b>			
Y20AA03G0A0A0A3	Tub	N/A	N/A
Y20HB03G0A0A0A3	SS Abutted Top & Tub	N/A	N/A
Y20HH03G0A0A0A3	Laminated Abutted Top & Tub	N/A	- - - - †
<b>60-in. (152.40cm) wide Stainless Steel Cabinet</b>			
Y20AA03G0A0A0A5	Tub	N/A	N/A
Y20HB03G0A0A0A5	SS Abutted Top & Tub	N/A	N/A
Y20HH03G0A0A0A5	Laminated Abutted Top & Tub	N/A	- - - - †

## Cupboard, Pair of Hinged Doors 18 Single-Depth Tub, Faucet Right

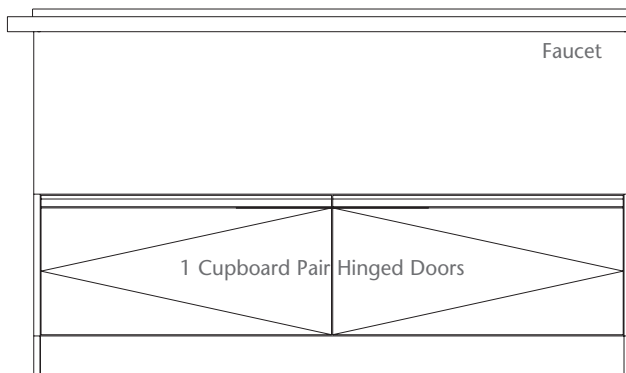

P/N	TOP STYLE	COLOR	
		CABINET	TOP
<b>IMPERIAL LAMINATED CABINET</b>			
<b>48-in. (121.92cm) wide Laminated Cabinet</b>			
L20AA04A0A0G0A3	Tub	- - - - †	N/A
L20HB04A0A0G0A3	SS Abutted Top & Tub	- - - - †	N/A
L20HH04A0A0G0A3	Laminated Abutted Top & Tub	- - - - †	- - - - †
<b>60-in. (152.40cm) wide Laminated Cabinet</b>			
L20AA04A0A0G0A5	Tub	- - - - †	N/A
L20HB04A0A0G0A5	SS Abutted Top & Tub	- - - - †	N/A
L20HH04A0A0G0A5	Laminated Abutted Top & Tub	- - - - †	- - - - †
<b>REGAL STAINLESS STEEL CABINET</b>			
<b>48-in. (121.92cm) wide Stainless Steel Cabinet</b>			
Y20AA04A0A0G0A3	Tub	N/A	N/A
Y20HB04A0A0G0A3	SS Abutted Top & Tub	N/A	N/A
Y20HH04A0A0G0A3	Laminated Abutted Top & Tub	N/A	- - - - †
<b>60-in. (152.40cm) wide Stainless Steel Cabinet</b>			
Y20AA04A0A0G0A5	Tub	N/A	N/A
Y20HB04A0A0G0A5	SS Abutted Top & Tub	N/A	N/A
Y20HH04A0A0G0A5	Laminated Abutted Top & Tub	N/A	- - - - †

**Important:** These customer order requirements, in addition to other customer order requirements, must be satisfied prior to the beginning of manufacturing lead time:

†Specify 4-digit Color code. See Color Selections, Section A, pages 1 & 2 for Color Codes.



SSCI laminated products are available in SSCI standard laminates, SSCI optional laminates, or Customer selected laminates.

# Imperial/Regal 6/18 Multi-Depth Tub Recessed-End Prep-Procedure Tables

**Imperial 6/18 Multi-Depth Recessed-End Prep-Procedure Table, 6/18 Multi-Depth Tub and Removable Prep Rack, Knee Space + Cupboard with Pair of Hinged Doors Faucet, on Right; sold separately, see Faucets Section.**



Hinged storage doors swing open to fit large or bulky items.

## 6/18 Multi-Depth recessed-End Prep-Procedure Table Cabinets

All 6/18 Multi-depth Recessed-end Prep-Procedure Tables include our 6/18 Multi-depth Tub and removable Prep Rack. These versatile Prep-Procedure Tables allow you to sit comfortably while performing procedures over the shallow portion of the stainless steel tub. Then remove the prep rack for access to deep tub for grooming and dipping treatments. Lower storage cupboard with sliding or hinged doors give you easy access to supplies. We offer these Tables with your choice of a durable, top-quality, high-pressure laminated **Imperial** Cabinet, or an all stainless steel **Regal** Cabinet for unsurpassed durability. **Imperial** laminated Tables are available in SSCI Standard colors, or SSCI optional colors or choose from a spectrum of customer-selected colors to blend with your décor. Tables are available with tub only or with a countertop and tub. Choose either stainless steel or laminated countertops.



**Regal 6/18 Multi-Depth Recessed-End Prep-Procedure Table, 6/18 Multi-Depth Tub and Removable Prep Rack, Knee Space + Cupboard with Pair of Hinged Doors Faucet, on Right; sold separately, see Faucets Section.**

# Imperial/Regal 6/18 Multi-Depth Tub Recessed-End Prep-Procedure Tables

## Knee Space + Cupboard, Pair of Sliding Doors 6/18 Multi-Depth Tub, Faucet Right

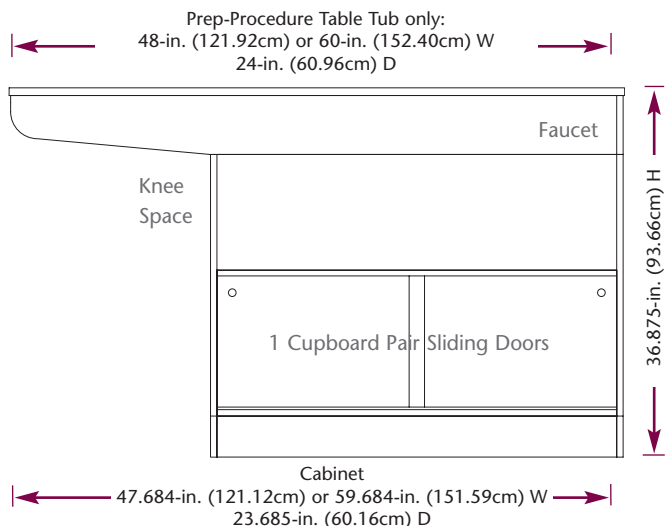

P/N	TOP STYLE	COLOR	
		CABINET	TOP
<b>IMPERIAL LAMINATED CABINET</b>			
48-in. (121.92cm) wide Laminated Cabinet			
L22AA04B1A0F0A3	Tub	- - - - †	N/A
L22HB04B1A0F0A3	SS Abutted Top & Tub	- - - - †	N/A
L22HH04B1A0F0A3	Laminated Abutted Top & Tub	- - - - †	- - - - †
60-in. (152.40cm) wide Laminated Cabinet			
L22AA04B1A0F0A5	Tub	- - - - †	N/A
L22HB04B1A0F0A5	SS Abutted Top & Tub	- - - - †	N/A
L22HH04B1A0F0A5	Laminated Abutted Top & Tub	- - - - †	- - - - †
<b>REGAL STAINLESS STEEL CABINET</b>			
48-in. (121.92cm) wide Stainless Steel Cabinet			
Y22AA04B1A0F0A3	Tub	N/A	N/A
Y22HB04B1A0F0A3	SS Abutted Top & Tub	N/A	N/A
Y22HH04B1A0F0A3	Laminated Abutted Top & Tub	N/A	- - - - †
60-in. (152.40cm) wide Stainless Steel Cabinet			
Y22AA04B1A0F0A5	Tub	N/A	N/A
Y22HB04B1A0F0A5	SS Abutted Top & Tub	N/A	N/A
Y22HH04B1A0F0A5	Laminated Abutted Top & Tub	N/A	- - - - †

## Cupboard, Pair of Sliding Doors + Knee Space 6/18 Multi-Depth Tub, Faucet Left

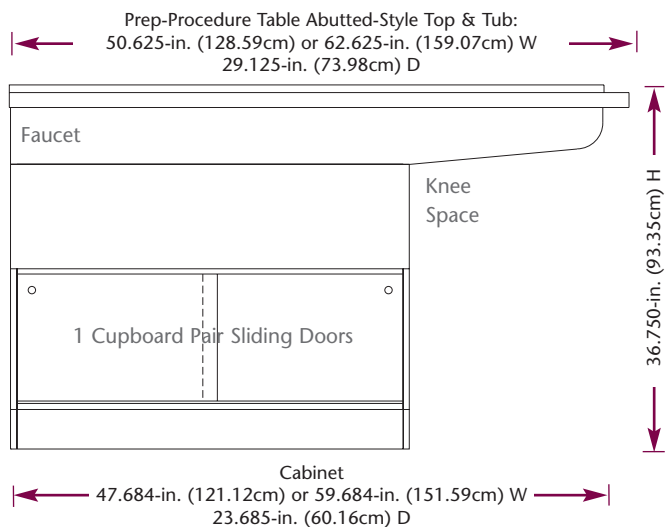

P/N	TOP STYLE	COLOR	
		CABINET	TOP
<b>IMPERIAL LAMINATED CABINET</b>			
48-in. (121.92cm) wide Laminated Cabinet			
L22AA03F0A0B1A3	Tub	- - - - †	N/A
L22HB03F0A0B1A3	SS Abutted Top & Tub	- - - - †	N/A
L22HH03F0A0B1A3	Laminated Abutted Top & Tub	- - - - †	- - - - †
60-in. (152.40cm) wide Laminated Cabinet			
L22AA03F0A0B1A5	Tub	- - - - †	N/A
L22HB03F0A0B1A5	SS Abutted Top & Tub	- - - - †	N/A
L22HH03F0A0B1A5	Laminated Abutted Top & Tub	- - - - †	- - - - †
<b>REGAL STAINLESS STEEL CABINET</b>			
48-in. (121.92cm) wide Stainless Steel Cabinet			
Y22AA03F0A0B1A3	Tub	N/A	N/A
Y22HB03F0A0B1A3	SS Abutted Top & Tub	N/A	N/A
Y22HH03F0A0B1A3	Laminated Abutted Top & Tub	N/A	- - - - †
60-in. (152.40cm) wide Stainless Steel Cabinet			
Y22AA03F0A0B1A5	Tub	N/A	N/A
Y22HB03F0A0B1A5	SS Abutted Top & Tub	N/A	N/A
Y22HH03F0A0B1A5	Laminated Abutted Top & Tub	N/A	- - - - †

**Important:** These customer order requirements, in addition to other customer order requirements, must be satisfied prior to the beginning of manufacturing lead time:

†Specify 4-digit Color code. See Color Selections, Section A, pages 1 & 2 for Color Codes.



SSCI laminated products are available in SSCI standard laminates, SSCI optional laminates, or Customer selected laminates.

# Imperial/Regal 6/18 Multi-Depth Tub Recessed-End Prep-Procedure Tables

## Knee Space + Cupboard, Pair of Hinged Doors 6/18 Multi-Depth Tub, Faucet Right

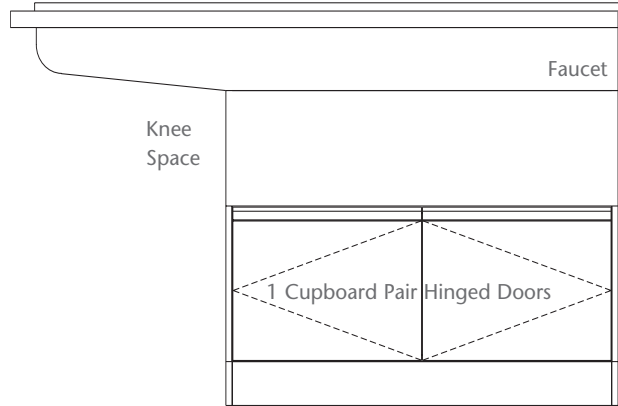

P/N	TOP STYLE	COLOR	
		CABINET	TOP
<b>IMPERIAL LAMINATED CABINET</b>			
<b>48-in. (121.92cm) wide Laminated Cabinet</b>			
L22AA04B1A0G0A3	Tub	- - - - †	N/A
L22HB04B1A0G0A3	SS Abutted Top & Tub	- - - - †	N/A
L22HH04B1A0G0A3	Laminated Abutted Top & Tub	- - - - †	- - - - †
<b>60-in. (152.40cm) wide Laminated Cabinet</b>			
L22AA04B1A0G0A5	Tub	- - - - †	N/A
L22HB04B1A0G0A5	SS Abutted Top & Tub	- - - - †	N/A
L22HH04B1A0G0A5	Laminated Abutted Top & Tub	- - - - †	- - - - †
<b>REGAL STAINLESS STEEL CABINET</b>			
<b>48-in. (121.92cm) wide Stainless Steel Cabinet</b>			
Y22AA04B1A0G0A3	Tub	N/A	N/A
Y22HB04B1A0G0A3	SS Abutted Top & Tub	N/A	N/A
Y22HH04B1A0G0A3	Laminated Abutted Top & Tub	N/A	- - - - †
<b>60-in. (152.40cm) wide Stainless Steel Cabinet</b>			
Y22AA04B1A0G0A5	Tub	N/A	N/A
Y22HB04B1A0G0A5	SS Abutted Top & Tub	N/A	N/A
Y22HH04B1A0G0A5	Laminated Abutted Top & Tub	N/A	- - - - †

## Cupboard, Pair of Hinged Doors + Knee Space 6/18 Multi-Depth Tub, Faucet Left

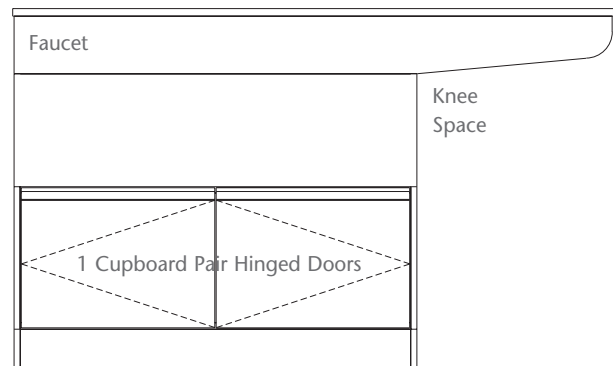

P/N	TOP STYLE	COLOR	
		CABINET	TOP
<b>IMPERIAL LAMINATED CABINET</b>			
<b>48-in. (121.92cm) wide Laminated Cabinet</b>			
L22AA03G0A0B1A3	Tub	- - - - †	N/A
L22HB03G0A0B1A3	SS Abutted Top & Tub	- - - - †	N/A
L22HH03G0A0B1A3	Laminated Abutted Top & Tub	- - - - †	- - - - †
<b>60-in. (152.40cm) wide Laminated Cabinet</b>			
L22AA03G0A0B1A5	Tub	- - - - †	N/A
L22HB03G0A0B1A5	SS Abutted Top & Tub	- - - - †	N/A
L22HH03G0A0B1A5	Laminated Abutted Top & Tub	- - - - †	- - - - †
<b>REGAL STAINLESS STEEL CABINET</b>			
<b>48-in. (121.92cm) wide Stainless Steel Cabinet</b>			
Y22AA03G0A0B1A3	Tub	N/A	N/A
Y22HB03G0A0B1A3	SS Abutted Top & Tub	N/A	N/A
Y22HH03G0A0B1A3	Laminated Abutted Top & Tub	N/A	- - - - †
<b>60-in. (152.40cm) wide Stainless Steel Cabinet</b>			
Y22AA03G0A0B1A5	Tub	N/A	N/A
Y22HB03G0A0B1A5	SS Abutted Top & Tub	N/A	N/A
Y22HH03G0A0B1A5	Laminated Abutted Top & Tub	N/A	- - - - †

**Important:** These customer order requirements, in addition to other customer order requirements, must be satisfied prior to the beginning of manufacturing lead time:

†Specify 4-digit Color code. See Color Selections, Section A, pages 1 & 2 for Color Codes.



SSCI laminated products are available in SSCI standard laminates, SSCI optional laminates, or Customer selected laminates.

**For Product Information Call TOLL-FREE 1-800-323-7366 • (847) 537-9320 • Fax (847) 537-9061**

**Hours: 8:30am - 5:00pm CST Monday - Friday**

Visit our website at: [www.suburbansurgical.com](http://www.suburbansurgical.com)

## Regal 6 Recessed End Dental-Procedure Tables



**Regal 6 Recessed End Dental-Procedure Table  
6 Single-Depth Tub and Removable Prep Rack,  
Cupboard, Door Hinged Left + 3 Drawers + Knee Space  
Faucet, on Left; sold separately, see Faucets Section.  
Shown with Ultima 250 Dental Unit.**

### Regal 6 Recessed End Dental-Procedure Tables

All Recessed-end Dental-Procedure Tables include our 6" Single-Depth tub and Removable Prep Rack. The cabinet is divided into 3 sections; one section can house a single or double compressor on a slide-out shelf; the middle section is available as 3 or 4 drawer storage space and a recessed knee space uses one section on the left or right end.

The recessed knee space is equipped with a swivel arm that allows the Ultima 250 Dental Unit to be accessed from either side of the Table.

We offer these Tables in an all stainless steel Regal Cabinet for unsurpassed durability. Tables are available with tub only or with a countertop and tub. Choose either stainless steel or laminated countertops.



**When not in use, Dental Unit stores  
out of the way under the knee space.**



# Regal 6 Recessed End Dental-Procedure Tables

P/N	TOP STYLE	COLOR	
		CABINET	TOP
<b>REGAL STAINLESS STEEL CABINET</b>			
60-in. (152.40cm) wide			
Y10AA04B3U0E2A5	Tub	N/A	N/A
Y10HB04B3U0E2A5	SS Abutted Top & Tub	N/A	N/A
Y10HH04B3U0E2A5	Laminated Abutted Top & Tub	N/A	- - - - †

## Knee Space + 3 Drawers + Cupboard, Door Hinged Right 6 Single-Depth Tub, Faucet Right

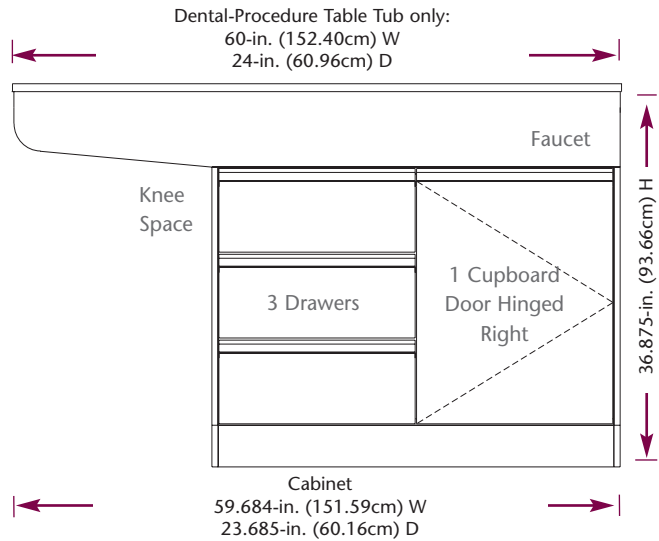

P/N	TOP STYLE	COLOR	
		CABINET	TOP
<b>REGAL STAINLESS STEEL CABINET</b>			
60-in. (152.40cm) wide			
Y10AA03D2U0B3A5	Tub	N/A	N/A
Y10HB03D2U0B3A5	SS Abutted Top & Tub	N/A	N/A
Y10HH03D2U0B3A5	Laminated Abutted Top & Tub	N/A	- - - - †

## Cupboard, Door Hinged Left + 3 Drawers + Knee Space 6 Single-Depth Tub, Faucet Left

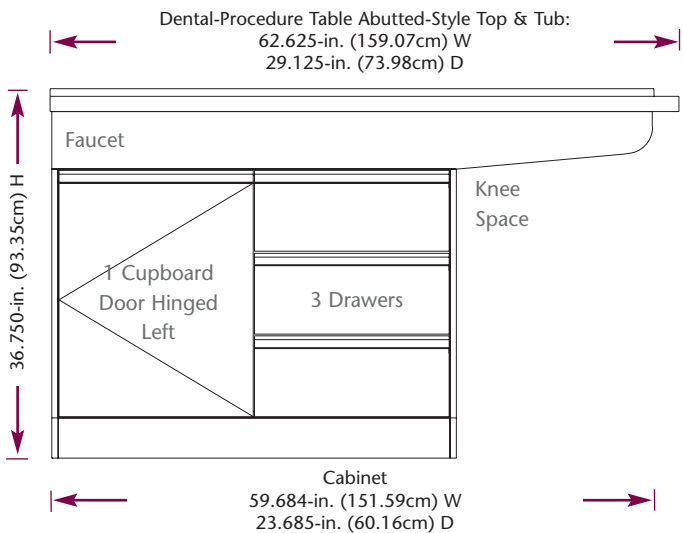

**Important:** These customer order requirements, in addition to other customer order requirements, must be satisfied prior to the beginning of manufacturing lead time:

† Specify 4-digit Color code. See Color Selections, Section A, pages 1 & 2 for Color Codes.



SSCI laminated products are available in SSCI standard laminates, SSCI optional laminates, or Customer selected laminates.

For Product Information Call TOLL-FREE 1-800-323-7366 • (847) 537-9320 • Fax (847) 537-9061

Hours: 8:30am - 5:00pm CST Monday - Friday

Visit our website at: [www.suburbansurgical.com](http://www.suburbansurgical.com)

# Regal 6 Recessed End Dental-Procedure Tables

## Knee Space + 4 Drawers + Cupboard, Door Hinged Right 6 Single-Depth Tub, Faucet Right

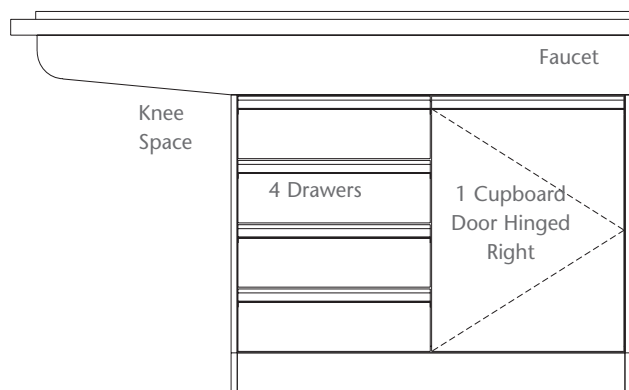

P/N	TOP STYLE	COLOR	
		CABINET	TOP
REGAL STAINLESS STEEL CABINET			
60-in. (152.40cm) wide			
Y10AA04B3V0E2A5	Tub	N/A	N/A
Y10HB04B3V0E2A5	SS Abutted Top & Tub	N/A	N/A
Y10HH04B3V0E2A5	Laminated Abutted Top & Tub	N/A	- - - - †

## Cupboard, Door Hinged Left + 4 Drawers + Knee Space 6 Single-Depth Tub, Faucet Left

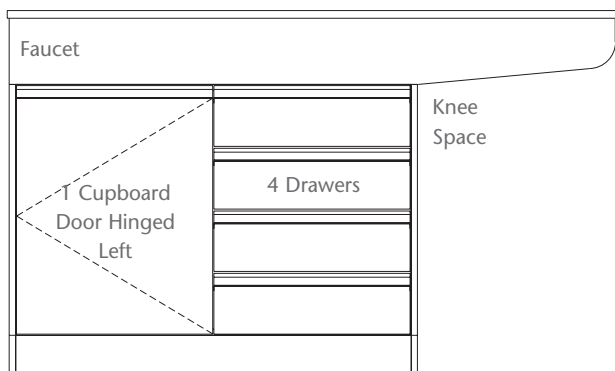

P/N	TOP STYLE	COLOR	
		CABINET	TOP
REGAL STAINLESS STEEL CABINET			
60-in. (152.40cm) wide			
Y10AA03D2V0B3A5	Tub	N/A	N/A
Y10HB03D2V0B3A5	SS Abutted Top & Tub	N/A	N/A
Y10HH03D2V0B3A5	Laminated Abutted Top & Tub	N/A	- - - - †

**Important:** These customer order requirements, in addition to other customer order requirements, must be satisfied prior to the beginning of manufacturing lead time:

†Specify 4-digit Color code. See Color Selections, Section A, pages 1 & 2 for Color Codes.



SSCI laminated products are available in SSCI standard laminates, SSCI optional laminates, or Customer selected laminates.

# Ultima 250 Dental Unit for Dental-Procedure Tables

## Ultima 250 Dental Unit

The Ultima 250 is a stylish three handpiece automatic control head with three-way syringe (water, air & mist). The variable speed foot control allows you to choose the desired speed for different types of procedures. The unit uses 2 one-liter bottles allowing the use of chlorhexadine in one bottle and distilled water in the other. A bottle selector switch allows change over from one bottle to the other so that chlorhexadine can be flushed from the system. The air lines are color-coded to distinguish between high and low-speed air lines and accessories. Unit is backed by a manufacturer's 2-year unconditional warranty covering all defective parts.

P/N	DESCRIPTION
12502-00-AAAAAA	Unit with accessory air line
12502-01-AAAAAA	Unit with Piezo Scaler
12502-02-AAAAAA	Unit with Fiber Optic High-Speed Air Line
12502-03-AAAAAA	Unit with both Piezo Scaler & Fiber Optic High-Speed Air Line

### Dental Unit Features

- Optional Venturi Suction System
- Low-speed Air Line (Red)
- Air Line for sonic scaling capability (White)
- High-speed Air Line (Blue)
- 3-way Air/Water Syringe included (No Color)
- Color-coded High-speed and Low-speed Air Lines for easy reference.

- 3-handpiece automatic control head with 3-way syringe. Removable top allows easy access to the internal components.
- Bottle selector switch allows change over from one bottle to the other so that chlorhexadine can be easily flushed from the system.
- Dual clean water system utilizing 2 one-liter bottles allowing the use of chlorhexadine in one bottle and distilled water in the other.
- Water-out quick disconnect to allow any ultrasonic scaler to be attached to the unit's pressurized water system.

\*Handpieces are customer supplied.

## Ultima Dental Venturi Suction System

Optional Venturi Suction System can be ordered with or added to any Ultima 250 Dental Unit.

P/N	DESCRIPTION
12503-00-AAAAAA	Venturi Suction System *Requires a double compressor.



Compressor slides out for easy access.

## Compressor

P/N	DESCRIPTION
12500-00-AAAAAA	Single-head Silent Surge Compressor 1/2 hp
12501-00-AAAAAA	Dual-head Silent Surge Compressor 1 hp

### Selecting a compressor

A dual-head compressor will compress twice the amount of air in half the time as a single-head compressor which will result in longer compressor life. Busy practices will find that a dual-head compressor will allow them the ability to practice dentistry for extended periods of time without fear of overheating the compressor.

# Finishing Accessories For Classic/Imperial/Regal Prep-Procedure Table



## Imperial Corner Edge Protectors

Keep your laminated Prep-Procedure Table looking brand-new with our stainless steel Corner Edge Protectors. They install easily with the included epoxy glue on laminated cabinet corners to help eliminate laminate chips and cracks caused by bumping or rubbing against the cabinet. Packaged in sets of two.

P/N	FITS TABLE STYLE
12811-00-AAAAAA	Fits Premier and Imperial Full-Cabinet Tables
12812-00-AAAAAA	Fits Imperial Recessed Tables

## Imperial/Regal Pull-out Trays

For greater convenience, replace the cupboard's existing adjustable shelf with Pull-out Trays. Our uniquely-designed rollers/slides ensure that the Pull-out moves quietly, smoothly and with little effort. Typically, two trays are customer-installed in each cupboard; one at the bottom and one midway. Pull-out trays for laminated products are white to match the interior of the cupboard. Pull-out trays for stainless steel products are stainless steel.



Each Pull-out Tray is sold separately

P/N FOR IMPERIAL TREATMENT TABLES	P/N FOR STAINLESS STEEL REGAL CABINETS	FITS CUPBOARD TYPE
DRPAEEAACJAODM	QRPAEEAACJAODM	Single Door in 48-in. 3 compartment Tables
DRPAEEAACZAODM	QRPAEEAACZAODM	Single Door in 60-in. 3 compartment Tables
DRPAEEAAETAODM	QRPAEEAAETAODM	Pair Doors in 48-in. 3 compartment Tables
DRPAEEAAFAODM	QRPAEEAAFAODM	Pair Doors in 60-in. 3 compartment Tables



## Classic Prep-Procedure Table Floor Sockets

Our heavy-gauge stainless steel Floor Sockets install on your floor to keep your Prep-Procedure Table securely in place. Simply install sockets on floor with appropriate hardware, then place Table legs inside. Sockets eliminate table movement for greater safety during procedures.

P/N	DESCRIPTION
12885-00-AAAAAA	Set of 4

## Classic Prep-Procedure Table Shelves

Heavy-gauge Stainless Steel Shelves let you keep towels, grooming supplies, instruments or equipment close at hand for easy access during procedures. Designed to be placed on cross members of the tubular base for easy installation. Lifts off easily for cleaning.

P/N	WIDTH	
	Inches	Centimeters
Fits Classic 6 and Classic 18 Tables		
12880-00-HHAEDC	48W	121.92W
12880-00-JDAEDC	60W	152.40W
Fits Classic 6 Recessed & Classic Multi-Depth Tables		
12880-00-EFAEDC	48W	121.92W
12880-00-EZAEDC	60W	152.40W



## Accessories For Prep-Procedure Table

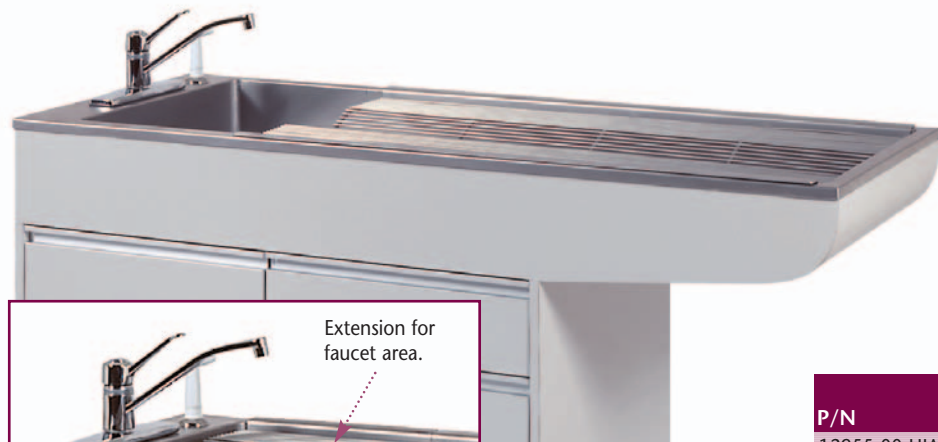

### "V" Prep-Procedure Rack

Stainless steel "V"-shaped Prep-Procedure Rack helps you hold patients steady during treatments. Features the same high-quality round rod construction as our Flat Prep Rack.

P/N	FITS TABLE WIDTH	
	Inches	Centimeters
12955-00-HJAADR	48W	121.92W
12955-00-JFAADR	60W	152.40W
12955-00-BWAADR	Extension for Faucet Area	

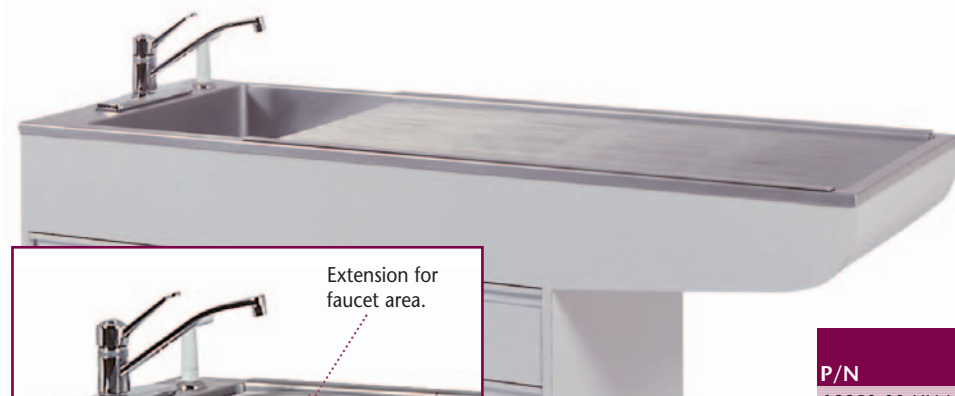

### Flat Prep-Procedure Rack

Order an extra Flat Prep-Procedure Rack to allow you to continue to treat patients while one rack is being cleaned and sanitized. Round rod stainless steel rack is welded at all intersections for strength and durability. Flush suspension rails hold rack securely in place in tub.

P/N	FITS TABLE WIDTH	
	Inches	Centimeters
12950-00-HJAADR	48W	121.92W
12950-00-JFAADR	60W	152.40W
12950-00-BWAADR	Extension for Faucet Area	



### Solid Removable Top

Simply place this Solid Top over your prep rack to turn your Prep-Procedure Table into an exam table when needed. Solid stainless steel Top allows you to use just one table for different types of treatments. Made of our heavy-duty Type 304 stainless steel for durability. Edges are hemmed all around to eliminate any sharp edges.

P/N	FITS TABLE WIDTH	
	Inches	Centimeters
12960-00-HJAADR	48W	121.92W
12960-00-JFAADR	60W	152.40W

# Accessories For Prep-Procedure Table



For 6 Recessed,  
6 and 18 Tables

## Stainless Steel Removable Bathing Rack

Fits into bottom of tub to give animal better footing during treatments. Allows water and loose hair and debris to flow through and down the drain away from the animal. Heavy-gauge stainless steel rack is welded at all intersections for strength and durability.

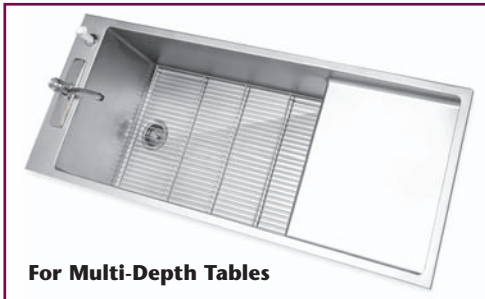

For Multi-Depth Tables

P/N	FITS TABLE STYLE	FITS TABLE WIDTH	
		Inches	Cm
12965-00-GHAFDG	6 Recessed, 6 and 18	48W	121.92W
12965-00-IDAFDG	6 Recessed, 6 and 18	60W	152.40W
12965-00-DXAFDG	Multi-Depth	48W	121.92W
12965-00-FDAFDG	Multi-Depth	60W	152.40W

For Multi-Depth Tables



## Coated Removable Bathing Rack

For greater animal comfort, choose this Coated Bathing Rack. Non-slip plastisol coating gives animals surer footing for even greater security during bathing and grooming. Fits into bottom of tub and allows water and loose hair and debris to flow through and down the drain away from the animal.

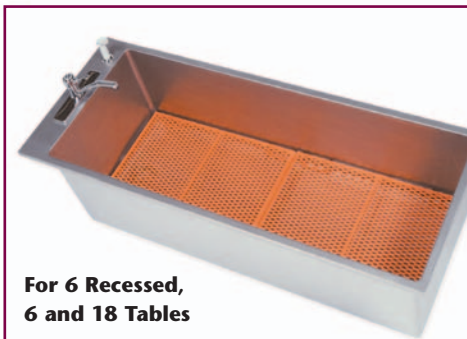

For 6 Recessed,  
6 and 18 Tables

P/N	FITS TABLE STYLE	FITS TABLE WIDTH	
		Inches	Cm
12970-00-GHALDG	6 Recessed, 6 and 18	48W	121.92W
12970-00-IDALDG	6 Recessed, 6 and 18	60W	152.40W
12970-00-DXALDG	Multi-Depth	48W	121.92W
12970-00-FDALDG	Multi-Depth	60W	152.40W

# Stainless Steel Tubs for Customer-Built Prep-Procedure Tables

**Our** heavy-gauge Type 304 stainless steel tubs are fully heli-arc welded into one piece to create the strongest tub available. Tubs has three holes for mounting 8-in. (20.32cm) spread faucet and one hole for spray hose. Accepts 3.5-in. (8.89cm) drain. Uniform, non-glare finish is easy-to-clean to keep these tubs looking like new.

## Prep-Procedure Single-Depth Tubs

P/N	WIDTH		DEPTH				FRONT TO BACK	
	In.	cm	SLOPES FROM In.	SLOPES FROM cm	SLOPES TO In.	SLOPES TO cm	In.	cm
Prep-Procedure 6 Single Depth Tub								
18180-00-HJAUDR	48	121.92	4.25	10.79	5.25	13.34	24	60.96
18180-00-JFAUDR	60	152.40	4.25	10.79	5.25	13.34	24	60.96
Prep-Procedure 18 Single Depth Tub								
18180-00-HJCQDR	48	121.92	16.25	41.27	17.25	43.81	24	60.96
18180-00-JFCQDR	60	152.40	16.25	41.27	17.25	43.81	24	60.96



## Prep-Procedure Multi-Depth Tub

P/N	WIDTH		SHALLOW END DEPTH				DEEP END DEPTH				FRONT TO BACK	
	In.	cm	SLOPES FROM In.	SLOPES FROM cm	SLOPES TO In.	SLOPES TO cm	SLOPES FROM In.	SLOPES FROM cm	SLOPES TO In.	SLOPES TO cm	In.	cm
Prep-Procedure 6/18 Multi-Depth Tub												
18181-00-HJCQDR	48	121.92	3.34	8.48	4.34	11.02	16.74	42.52	17.34	44.04	24	60.96
18181-00-JFCQDR	60	152.40	3.34	8.48	4.34	11.02	16.74	42.52	17.34	44.04	24	60.96

**FOR EVERY LAMINATED PRODUCT PURCHASE, SSCI CREATES A DRAWING TO ENSURE CUSTOMER'S SATISFACTION**

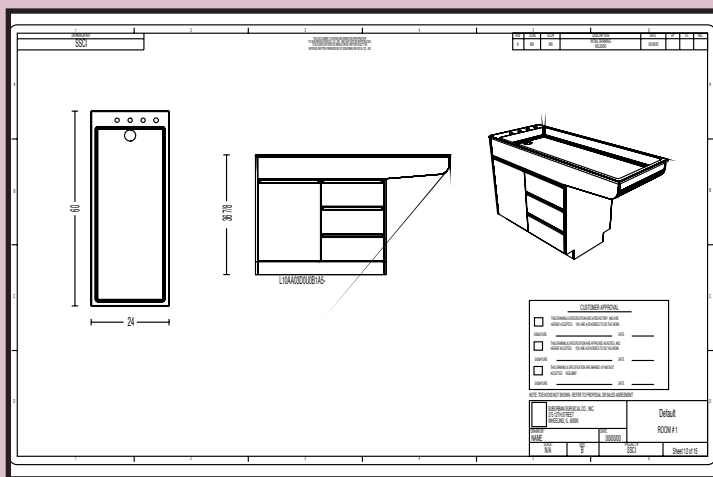

SSCI creates an Approval Drawing for each laminated product ordered. These detailed drawings of your laminated product illustrates the product and specifies your laminate choice. If you choose to change your choice of laminate, do not sign the existing Approval Drawing. Contact your SSCI representative, so that a new Approval Drawing can be created. All laminated products are non-stocked, made specifically per your specifications. Once SSCI has received the signed Approval Drawing the order is non-cancelable. In addition to other customer requirements, the Final Approval Drawings must be signed and received by SSCI prior to the beginning of manufacturing lead time.