



Surgical Drapes and Gowns

Contents

Surgical gowns..... 1-6

SmartGown™.....	4
SmartSleeve™.....	4
RoyalSilk®.....	5
Astound®.....	5-6
Apron and sleeves.....	6



Surgical drapes and packs..... 7-90

Ancillary.....	9-12
Angiography.....	13-17
Cardiovascular.....	19-22
Cystoscopy.....	23-24
General surgery.....	25-32
Neurology.....	33-34
Obstetrics.....	35-37
Ophthalmology and EENT.....	39-43
Orthopedics.....	45-57
Pediatrics.....	59-61
Peri-GYN.....	63-67
Standard Packs.....	69-90



Index..... 91-97

Catalog number index.....	91-92
Bulk nonsterile index.....	93-95
Product index.....	96-97



Surgical drapes and packs

The three-layers of protection in Tiburon® surgical drapes control the potentially infectious fluids inherent in every procedure.

- The top layer works by absorbing fluids rather than repelling them, containing them on the spot.
- The middle layer is reinforced with our proprietary advanced Strike-Through Barrier Technology, which makes the drape strong and impervious.
- A soft bottom layer ensures patient comfort and provides additional strength.

Provide the critical recommended protection against blood and viral penetration.

According to the **CDC 1999 Guidelines for Prevention of Surgical Site Infection**¹, surgical drapes should be impervious to both blood and viral penetration. Our advanced proprietary three-layer technology allows Tiburon® to pass both these stringent industry tests for blood and viral penetration, ASTM F1670 and ASTM F1671.

Control runoff.

The top layer controls fluids, providing quicker room turnover time and an overall safer work environment.

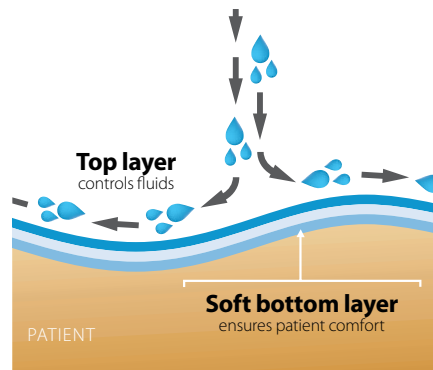
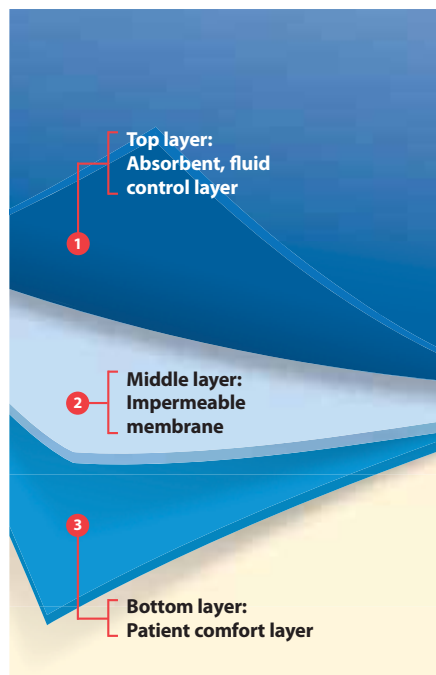

Surgical gowns

Be in the know and know you are protected with Cardinal Health surgical gowns.

Inspired by long days on your feet, our surgical gowns stand up to the rigors of your work, keeping you safe from potentially harmful elements.

In creating SmartGown™, RoyalSilk® and Astound® surgical gowns, we worked closely with healthcare professionals like you to make sure your needs and expectations were not just met, but exceeded.



SmartGown™

Cardinal Health brings you a breathable, fully impervious surgical gown that is a leader in the industry.



RoyalSilk®

The most comfortable surgical gown available.¹



Astound®

Astound® is the #1 choice of industry professionals worldwide.

What will you be wearing?

It's important to choose the right gown for the right procedure. Clinicians and surgeons should begin the surgical gown selection process by answering the following four questions to determine the appropriate level of protection:

- What type of procedure is being performed?
- How long will the procedure last?
- How much fluid will be present during the case?
- What is the clinician's role in the procedure?²

Least protective



Most protective

AAMI levels

In an effort to help protect healthcare workers, all surgical gowns are categorized by a barrier performance level which is designated by the AAMI and based on Standard PB70:2003.

Cardinal Health only manufactures AAMI level 3 and level 4 surgical gowns.

To learn more, contact your sales representative or email PresourceSolutions@cardinalhealth.com

¹Project #02868.

² www.infectioncontrolday.com/articles/2006/11/barrier-protection.aspx



Surgical gowns

For every healthcare professional and every procedure that is performed, Cardinal Health delivers exceptional AAMI level 3 and 4 surgical gown solutions, providing a unique balance of comfort, value and protection.

SmartGown™

SmartSleeve™

RoyalSilk®

Astound®

Apron and sleeves

SmartGown™ Surgical Gowns



89013 SmartGown™ Surgical Gowns and 890015N SmartGown™ Surgical Gowns and Scrub Nurse

SmartGown™ Surgical Gowns

Sterile No.	Nonsterile No.	Size	Type	Qty. Cs
89013	89013N	X-Small	Set-in Sleeve	20
89005	89005N	Small/Medium	Set-in Sleeve	20
89015	89015N	Large	Set-in Sleeve	20
89045	89045N	X-Large	Set-in Sleeve	18
89075	89075N	XX-Large	Set-in Sleeve	14
39015	39015N	Large	Raglan Sleeve	20
39045	39045N	X-Large	Raglan Sleeve	18
39049	39049N	X-Large, X-Long	Raglan Sleeve	14
39075	39075N	XX-Large	Raglan Sleeve	14
39079	39079N	XX-Large, X-Long	Raglan Sleeve	14
39099	39099N	XXX-Large, X-Long	Raglan Sleeve	14
32474	32474N	X-Large, X-Long, A-line	Raglan Sleeve	16

SmartGown™ Surgical Gowns, Scrub Nurse

Sterile No.	Nonsterile No.	Size	Type	Qty. Cs
N/A	890015N	Large, with towel in outer wrap	Set-in Sleeve	N/A
N/A	890045N	X-Large, with towel in outer wrap	Set-in Sleeve	N/A



9011 SmartSleeve™ Surgical and 90020N SmartSleeve™ Surgical Gown, Scrub Nurse

SmartSleeve™ Surgical Gowns

Sterile No.	Nonsterile No.	Size	Type	Qty. Cs
9011	9011N	Large	Set-in Sleeve	20
9011EL	9011ELN	Large, X-long	Set-in Sleeve	20
9041	9041N	X-Large	Set-in Sleeve	20
9041EL	9041ELN	X-Large, X-Long	Set-in Sleeve	20
9071	9071N	XX-Large	Set-in Sleeve	20
9071EL	9071ELN	XX-Large, X-Long	Set-in Sleeve	20
9560	9560N	XXX-Large, X-Long	Set-in Sleeve	20

SmartSleeve™ Surgical Gowns, Scrub Nurse

Sterile No.	Nonsterile No.	Size	Type	Qty. Cs
N/A	90020N	Large, with towel in outer wrap	Set-in Sleeve	N/A
N/A	90030N	X-Large, with towel in outer wrap	Set-in Sleeve	N/A

RoyalSilk® Surgical Gowns

RoyalSilk® Surgical Gowns

Sterile No.	Nonsterile No.	Size	Type	Qty. Cs
9518	9518NA	Large	Set-in Sleeve	20
9548	9548NA	X-Large	Set-in Sleeve	20
9578	9578NA	XX-Large	Set-in Sleeve	18
95998	95998N	XXX-Large, X-Long	Set-in Sleeve	20



9518 RoyalSilk® Surgical Gowns and 90280NA RoyalSilk® Surgical Gowns, Scrub Nurse

RoyalSilk® Surgical Gowns, Scrub Nurse

Sterile No.	Nonsterile No.	Size	Type	Qty. Cs
N/A	90280NA	Large, with towel in outer wrap	Set-in Sleeve	N/A
N/A	90380NA	X-Large, with towel in outer wrap	Set-in Sleeve	N/A

Astound® Surgical Gowns

Astound® Standard Gowns

Sterile No.	Nonsterile No.	Size	Type	Qty. Cs
9505	N/A	Small/medium	Set-in Sleeve	20
9515	9515NA	Large	Set-in Sleeve	20
9545	9545NA	X-Large	Set-in Sleeve	20
9575	9575NA	XX-Large	Set-in Sleeve	18
95995	95995N	XXX-Large, X-Long	Set-in Sleeve	20



9515 Astound® Standard Surgical Gowns and 90270NA Astound® Standard Gowns, Scrub Nurse

Astound® Standard Gowns, Scrub Nurse

Sterile No.	Nonsterile No.	Size	Type	Qty. Cs
N/A	90270NA	Large, with towel in outer wrap	Set-in Sleeve	N/A
N/A	90370NA	X-Large, with towel in outer wrap	Set-in Sleeve	N/A

Astound® Surgical Gowns



9511 Astound® Fabric-Reinforced Gowns and 90970N Astound® Fabric-Reinforced Gowns, Scrub Nurse



9010 Astound® Poly-Reinforced Gowns and 90680NA Astound® Poly-Reinforced Gowns, Scrub Nurse

Astound® Fabric-Reinforced Gowns

Sterile No.	Nonsterile No.	Size	Type	Qty. Cs
9511	9511N	Large	Set-in Sleeve	20
9541	9541N	X-Large	Set-in Sleeve	20
9571	9571N	XX-Large	Set-in Sleeve	20

Astound® Fabric-Reinforced Gowns, Scrub Nurse

Sterile No.	Nonsterile No.	Size	Type	Qty. Cs
N/A	90970N	Large, with towel in outer wrap	Set-in Sleeve	N/A
N/A	91070N	X-Large, with towel in outer wrap	Set-in Sleeve	N/A

Astound® Poly-Reinforced Gowns

Sterile No.	Nonsterile No.	Size	Type	Qty. Cs
9010	9010N	Large	Set-in Sleeve	20
9040	9040N	X-Large	Set-in Sleeve	20
9070	9070N	XX-Large	Set-in Sleeve	18

Astound® Poly-Reinforced Gowns, Scrub Nurse

Sterile No.	Nonsterile No.	Size	Type	Qty. Cs
N/A	90680NA	Large, with towel in outer wrap	Set-in Sleeve	N/A
N/A	90780N	X-Large, with towel in outer wrap	Set-in Sleeve	N/A

Apron and Sleeves

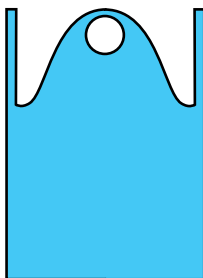

Heavy-Duty Disposable Cystoscopy Apron

- Made of ethylene vinyl acetate
- Protective area measures 37 x 42½ in.
- Nonsterile

Cat. No.	Qty. Bx	Qty. Cs
3175	20	80/cs



Sterile Disposable Sleeves

- Quick sterile coverage for contaminated gown sleeves
- Elastic at both ends for ease of donning
- 21½ in. minimum in length

Sterile No.	Qty. Bx	Qty. Cs
599	30	60/cs



Surgical Drapes and Packs

Tiburon® surgical drapes are engineered to pass the industry standard tests that measure fluid and synthetic viral penetration, which help provide the maximum in clinician and patient safety. They are resistant to abrasion and puncture, yet their flexible, cloth-like properties allow them to drape naturally, following the contours of the patient.

The impervious structure of Tiburon® surgical drapes can help reduce the occurrence of strikethrough, which creates a pathway for microorganisms, that can lead to contamination and infection. In addition, the absorbent top layer can effectively hold and disperse fluid away from the patient.

Classified as a Level 4 device under the AAMI guidelines for barrier performance, Tiburon® surgical drapes provide the highest level of protection available in a surgical drape.¹ Tiburon® fabric also passes the even more stringent industry test for viral penetration, ASTM F1671.¹

Ancillary
Angiography
Cardiovascular
Cystoscopy
General surgery
Neurology
Obstetrics
Ophthalmology
Orthopedics
Pediatrics
Peri-GYN
Custom drapes

¹ Visit www.cdc.gov/ncidod/dhqp/gl_surgalsite.html for more information.

Cardinal Health is the leading manufacturer of surgical drapes and gowns in the industry.

Relax and focus on what matters most — your patients.

Protect your patients and your bottom line with our surgical drapes.

Cardinal Health surgical drapes feature larger adhesive strips, so they stay in place during even the longest procedures. Our surgical drapes are designed to cover the patient's entire body and feature increased armboard cover width.

Strength in numbers

Tiburon® and Astound™ surgical drapes beat out the leading competitors in critical industry standard tests. With unbeatable performance on your team, everybody wins.

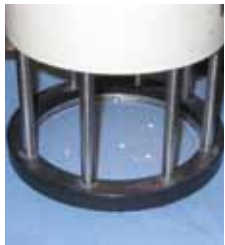

Strike-through resistance test (in cm)

↑ Higher is better

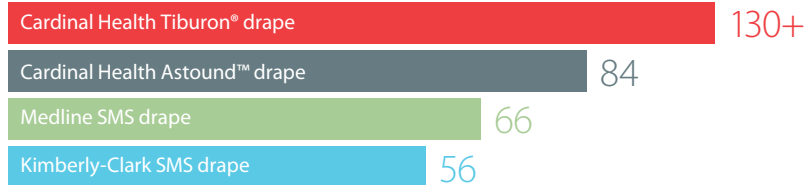

Puncture resistance test (in psi)

↑ Higher is better

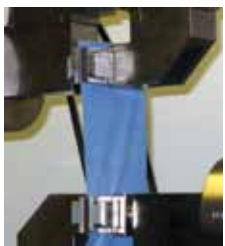

Strength test (machine direction in lbs.)

↑ Higher is better

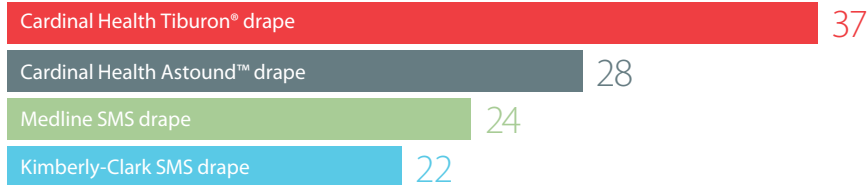

Lint test (in number of particles ≥1 micron)

↓ Lower is better

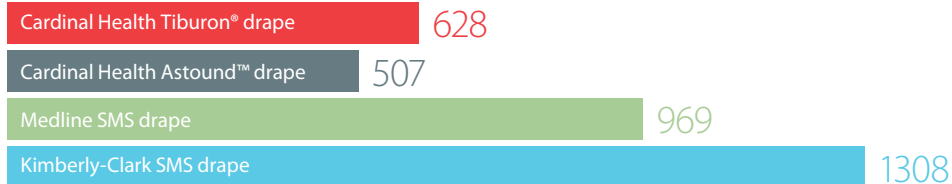

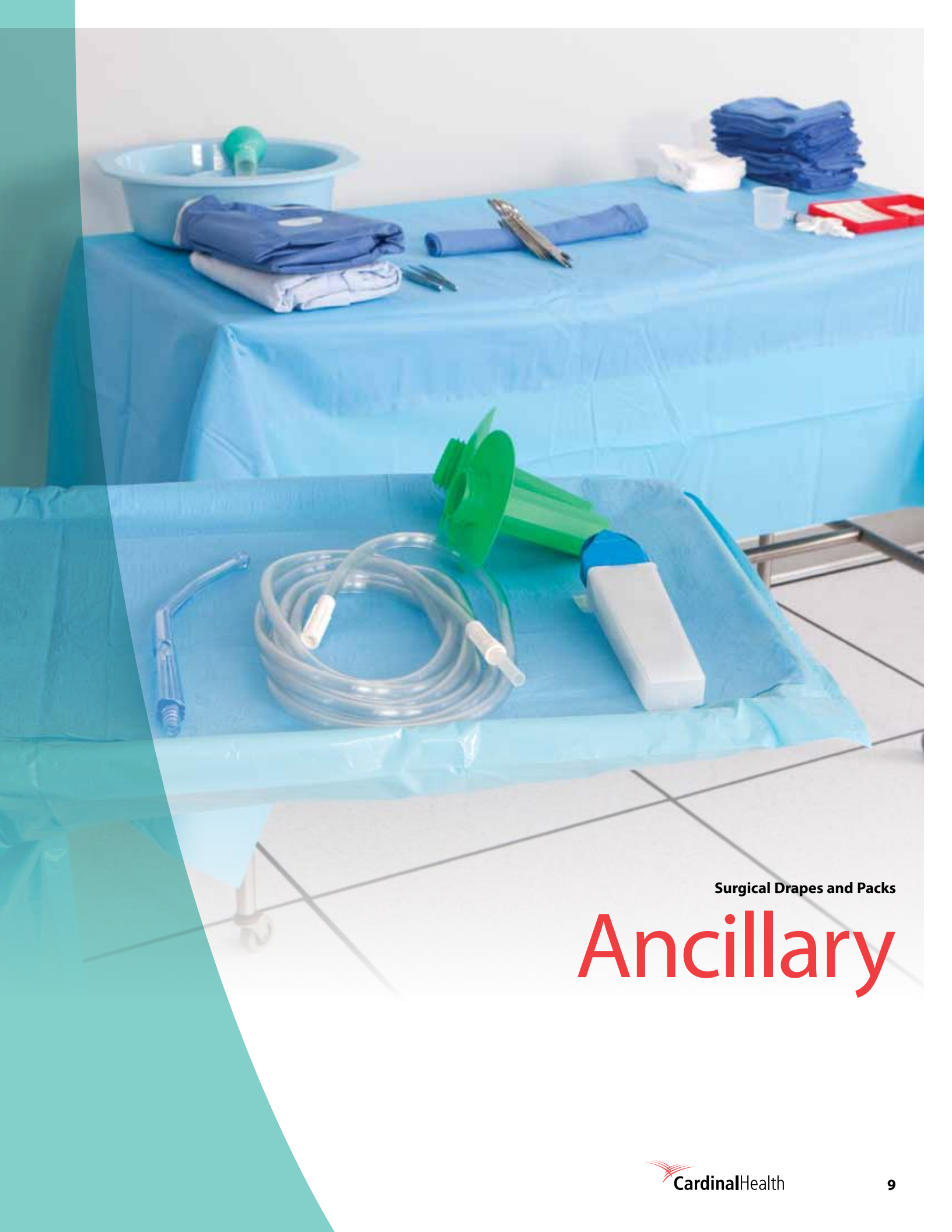

Surgical Drapes and Packs

Ancillary

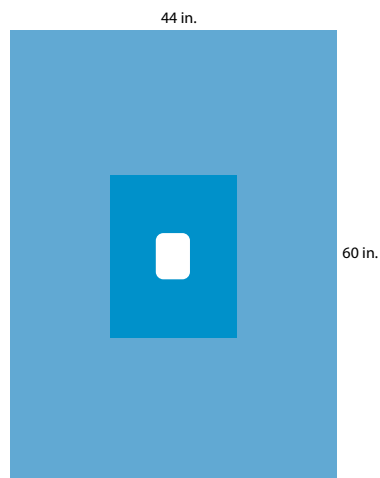
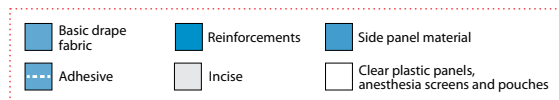

9462 Astound™ Utility Drape Sheet

Utility Drape Sheet

Cat. No.	Nonsterile No.	Description	Qty. Cs
9462	9462N	Astound™ utility drape sheet, 44 x 60 in., 4 x 6 in. poly-reinforced fenestration	20

Drape Tape

Cat. No.	Nonsterile No.	Description	Qty. Pkg	Qty. Cs
3524	N/A	Drape tape, 4 in. x 18½ in.	2	160

Drape Towels

Cat. No.	Nonsterile No.	Description	Qty. Pkg	Qty. Cs
7553	8554N	Blue drape towel, non-absorbent with adhesive strip, sterile, 15 x 26 in.	2	120
7554	7554N	Tiburon® drape towel, with adhesive strip, sterile, 19 x 30 in.	2	60
3523	N/A	Fenestrated poly-lined towel, absorbent, 18 x 26 in., 2½ in. aperture, sterile, 50/box, 2 bx/cs		100
N/A	8520N	Absorbent towel, white, 15½ in. x 22 in.		
N/A	9460N	Peri-towel, 7½ x 22 in.		
8553	N/A	Fenestrated towel, sterile, 19¼ x 26 in., 2¾ in. aperture, blue	1	120
3520	N/A	Polylined towel, absorbent, white, 18 x 26 in.	1	100
7552	N/A	Blue drape towel, non-absorbent, sterile, 15 x 26 in.	2	120
SPP99GSUDA	N/A	Utility drape pack, blue drape towel, non-absorbent with adhesive strip, sterile, 15 x 26 in.	4	70
N/A	8365N	Set-up cover, 44 x 71 in.		

Standard Reinforced Back Table Covers

Cat. No.	Nonsterile No.	Description	Qty. Cs
8376	8145N	Standard back table cover, 44 x 75 in., SMS reinforcement, 23 x 75 in.	22
8377	8146N	Standard back table cover, 44 x 90 in., SMS reinforcement, 23 x 90 in.	22
8378	8184N	Standard back table cover, 50 x 90 in., SMS reinforcement, 29 x 90 in.	24
8380	8187N	Standard back table cover, 80 x 90 in., SMS reinforcement, 40 x 90 in.	22
9385	8188N	Overhead table cover, 80 x 90 in., reinforced poly with 44 x 72 in. fabric sterile field extension, SMS reinforcement, 40 x 90 in.	12
8145W	8145NW	Standard back table cover for ophthalmic procedures, 44 x 75 in., cellulose reinforcement, 23 x 75 in.	22
8146W	8146NW	Standard back table cover for ophthalmic procedures, 44 x 90 in., cellulose reinforcement, 23 x 90 in.	22
8184W	8184NW	Standard back table cover for ophthalmic procedures, 50 x 90 in., cellulose reinforcement, 29 x 90 in.	24
	8191N	Standard back table cover, 50 x 47 in., SMS reinforcement, 30 x 47 in.	N/A

Mayo Stand Covers

Cat. No.	Nonsterile No.	Description	Qty. Cs
8337	8337N	Mayo stand cover, reinforced poly, 23 x 55 in.	30
8339	8339NI	Mayo stand cover, reinforced poly, 29½ x 55 in.	22

Heavy-Duty Reinforced Back Table Covers

Cat. No.	Nonsterile No.	Description	Qty. Cs
8386	8153N	Heavy-duty back table cover, 65 x 90 in., SMS reinforcement, 28 x 90 in.	12
8385	8152N	Heavy-duty back table cover, 80 x 110 in., SMS reinforcement, 37 x 110 in.	10
8186	8186N	Heavy-duty back table cover, 80 x 110 in., SMS reinforcement, 29 x 90 in.	24
8186W	8186NW	Heavy-duty back table cover for ophthalmic procedures, 65 x 90 in., cellulose reinforcement, 29 x 90 in.	24

**Drape Sheets**

Cat. No.	Nonsterile No.	Description	Qty. Cs
9358	9358N	Astound™ half sheet, 44 x 57 in.	20
TB9358CE	TB9358NI	Tiburon® half sheet, 44 x 57 in.	20
9355	9355N	Astound™ medium sheet, 44 x 71 in.	20
TB9355CE	N/A	Tiburon® medium sheet, 44 x 71 in.	20
9349	9349N	Astound™ three-quarter sheet, 60 x 76 in.	20
TB9349CE	TB9349NI	Tiburon® three-quarter sheet, 60 x 76 in.	20
29350	29350N	Astound™ three-quarter sheet, 56 x 77 in., with absorbent reinforcement, 25 x 42 in.	20
9446	9446N	Astound™ large sheet, 72 x 85 in.	30
9444	9444N	Astound™ X-large sheet, 77 x 98 in.	12
N/A	8470N	Plastic setup cover, 50 x 59 in.	
8750	N/A	Prep pad, absorbent, 9 in. cuff, 24 x 41 in., nonsterile	50

Drape Sheet, Square-Folded

Cat. No.	Nonsterile No.	Description	Qty. Cs
9461	9461N	Astound™ drape sheet, square-folded, 38½ x 38½ in.	30

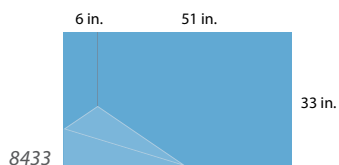
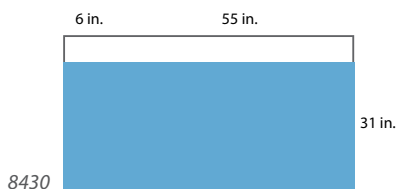
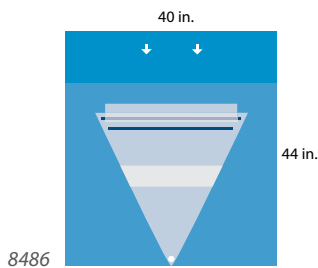
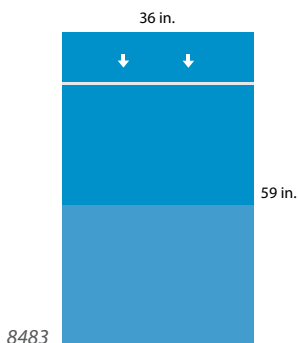
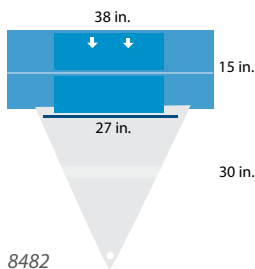
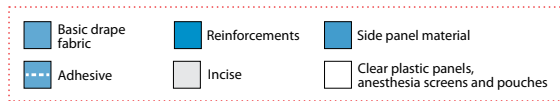

Under-Buttocks Drapes

Cat. No.	Nonsterile No.	Description	Qty. Cs
8482	8482N	Under-buttocks drape, with fluid control pouch, filtering screen, drainage port and reinforcement	20
8483	8483N	Under-buttocks drape, reinforced poly, 9 in. cuff, 36 x 59 in.	40
8484	8484N	Under-buttocks drape with fluid control pouch, reinforcement	20
8486	8486N	Under-buttocks drape, fluid control pouch with filtering screen and drainage port, plastic backing	20
8461	8461N	Under-buttocks drape, fluid control pouch with filtering screen and drainage port, plastic backing with reinforcement on cuff	20

Leggings

Cat. No.	Nonsterile No.	Description	Qty. Cs
8420	8420NA	Leggings, folded, 6 in. cuff, 28 x 43 in., 2/pkg.	20
8421	8421N	Leggings, folded, 6 in. cuff, 31 x 48 in., 2/pkg.	20
8430	8430NA	InView® clear leggings, folded, 6 in. cuff, 31 x 55 in., 2/pkg	20
8433	8433N	Extra large leggings, folded, 6 in. cuff, 33 x 51 in., 2/pkg.	20

Impervious Stockinettes

Cat. No.	Nonsterile No.	Description	Size (in.)	Qty. Cs
1584	N/A	Impervious stockinette, small	6 x 30 in.	30
1585	1585N	Impervious stockinette, medium	8 x 38 in.	30
1586	1586N	Impervious stockinette, large	9 x 48 in.	40
1587	1582N	Impervious stockinette, X-large	12 x 48 in.	40

Poly U-Drapes

Cat. No.	Nonsterile No.	Description	Size (in.)	Qty. Cs
8474	8474N	Poly U-drape, 6 x 21 in. split with adhesive	60 x 60 in.	28
8475	8475N	Poly U-drape, 8 x 30 in. split with adhesive	60 x 84 in.	22
8476	8476NA	Poly U-drape, 6 x 21 in. split with adhesive	60 x 72 in.	24

Cord Management Tabs

Cat. No.	Description	Qty. Cs
1590SSA	Cord holding 1 x 5 in. adhesive strap with VELCRO® fasteners, X-ray detectable, 2/pkg.	50 packages per box, 4 boxes per case

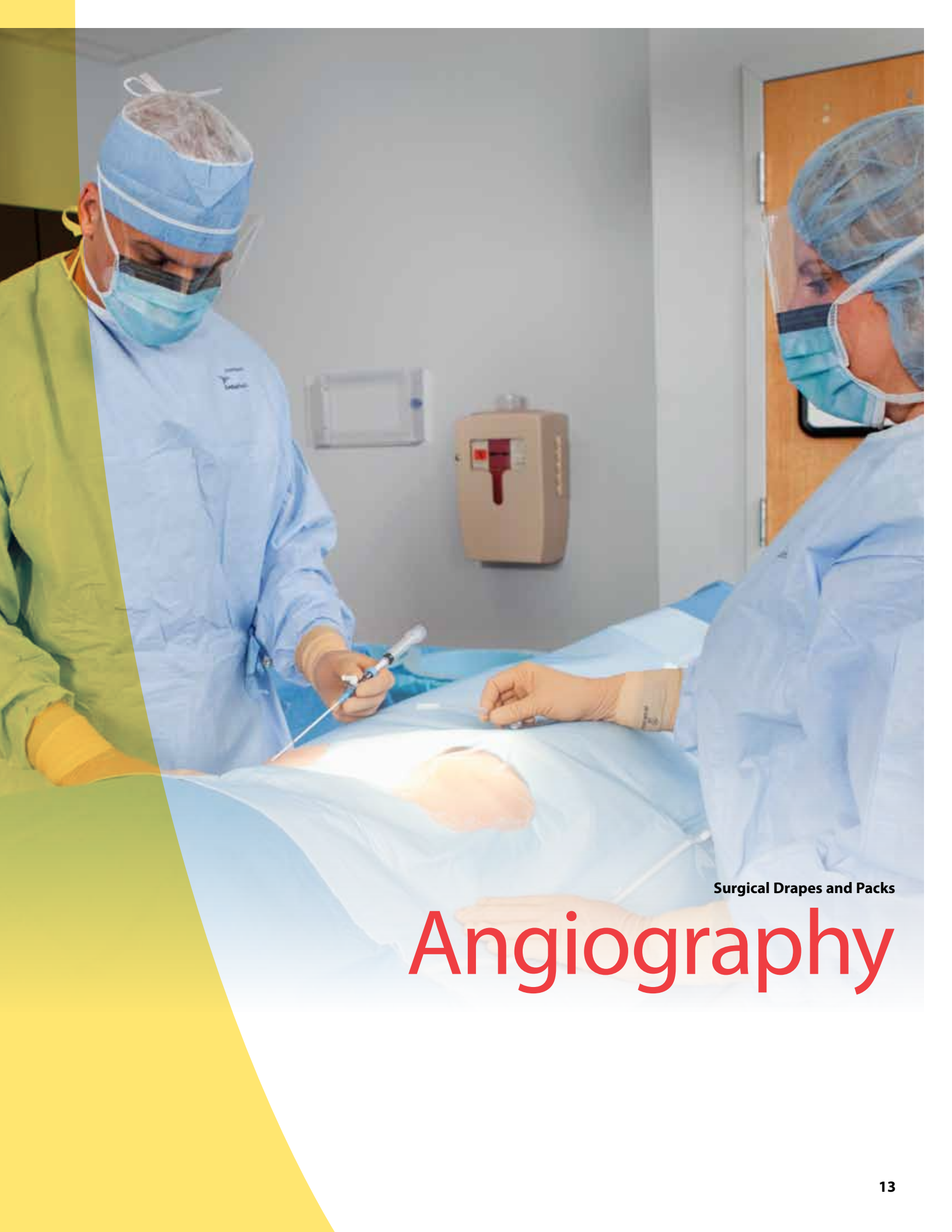

Surgical Drapes and Packs

Angiography

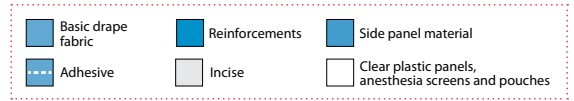

Tiburon® Femoral Angiography Drape

Cat. No.	Nonsterile No.	Qty. Cs
29460	29460N	16

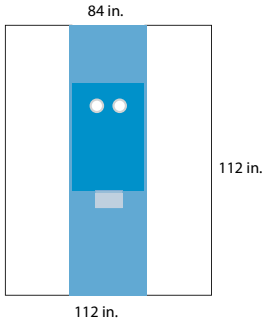

- Absorbent, impervious reinforcement, 28¾ x 44 in.
- Catheter pouch, 8½ x 11½ in.
- Clear side panels, 27½ x 112 in.
- Fenestration, dual circular, 6 in., with circular incise aperture, 3½ in.

Tiburon® Femoral Angiography Drape

Cat. No.	Nonsterile No.	Qty. Cs
29520	29520N	16

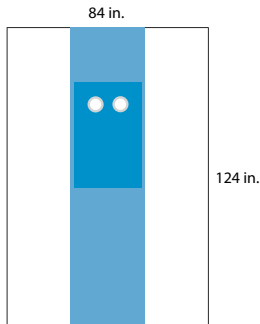

- Absorbent, impervious reinforcement, 28¾ x 44 in.
- Clear side panels, 27½ x 124 in.
- Fenestration, dual circular, 6 in., with circular incise aperture, 3½ in.

Extra Large Femoral Angiography Drape

Cat. No.	Nonsterile No.	Qty. Cs
29570	29570N	8

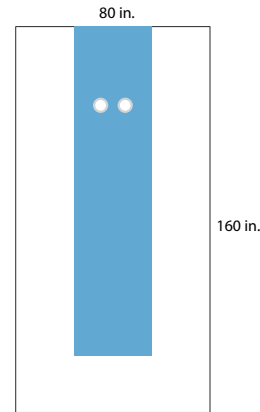

- Absorbent, reinforcement, 33½ x 135 in.
- Clear foot panel, 80 x 25 in.
- Clear side panels, 23¼ x 135 in.
- Fenestration, dual circular, 6 in., with circular incise aperture, 3½ in.

Femoral Angiography Drape with Trough

Cat. No.	Nonsterile No.	Qty. Cs
29560	29560N	8

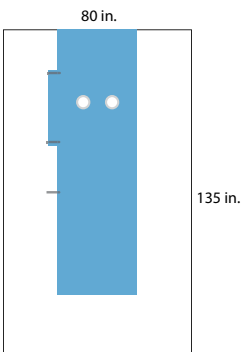

- Absorbent, reinforcement, 33½ x 111 in.
- Clear foot panel, 80 x 24 in.
- Clear side panels, 23 x 111 in.
- Fenestration, dual circular, 6 in., with circular incise aperture, 3½ in.
- Malleable bars with 4 x 32 in. trough

Tiburon® Femoral Angiography Drape

Cat. No.	Nonsterile No.	Qty. Cs
29456	29456N	14

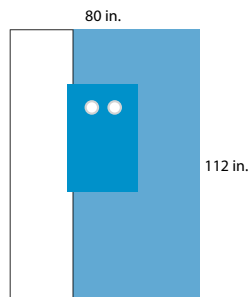

- Absorbent, impervious reinforcement, 29 x 44 in.
- Fenestration, dual circular, 6 in., with circular incise aperture, 3½ in.
- Single clear side panel on patient's right side, 26½ x 112 in.

Tiburon® Femoral Angiography Drape with Expanded Reinforcement

Cat. No.	Nonsterile No.	Qty. Cs
29556	29556NA	8

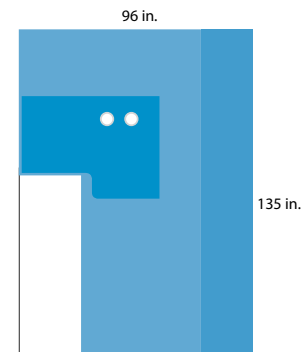

- Absorbent, impervious reinforcement, 28¾ x 44 in. (fenestrated area); 28¾ x 32 in. above clear panel
- Fenestration, dual circular, 6 in., with circular incise aperture, 3½ in.
- Single clear side panel on patient's right side, 26 x 75 in.

Tiburon® Femoral Angiography Drape with Catheter Pouch

Cat. No.	Nonsterile No.	Qty. Cs
29459	29459N	16

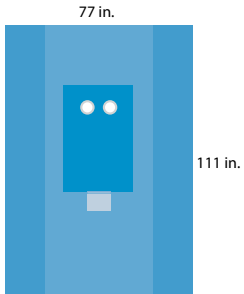

- Absorbent, impervious reinforcement, 29 x 44 in.
- Catheter Pouch, 8½ x 11½ in.
- Fenestration, dual circular, 6 in., with circular incise aperture, 3½ in.

Tiburon® Femoral Angiography Drape with Catheter Pouch

Cat. No.	Nonsterile No.	Qty. Cs
N/A	29489N	

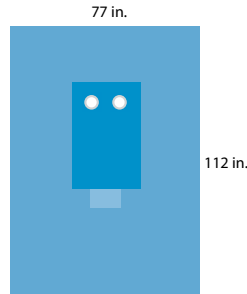

- Absorbent, impervious reinforcement, 29 x 44 in.
- Catheter Pouch, 8½ x 11½ in.
- Fenestration, dual circular, 6 in., with circular incise aperture, 3½ in.

Pacemaker Drape

Cat. No.	Nonsterile No.	Qty. Cs
29013	29013N	8

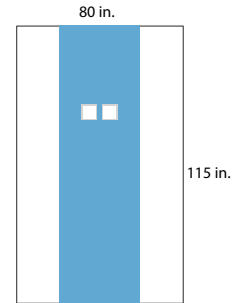

- Absorbent, reinforcement, 33½ x 115 in.
- Clear side panels, 23 x 115 in.
- Fenestration, dual square, 6 in., with square incise aperture, 4 in.

Tiburon® Brachial Angiography Drape

Cat. No.	Nonsterile No.	Qty. Cs
29458	29458N	40

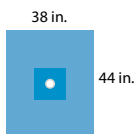

- Absorbent, impervious reinforcement, 12 x 12 in.
- Fenestration, circular incise aperture, 4 in.

Tiburon® Brachial Angiography Drape

Cat. No.	Nonsterile No.	Qty. Cs
29461	29461N	10

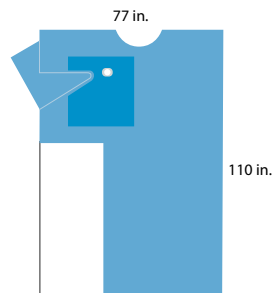

- Absorbent, impervious reinforcement, 28 x 29 in.
- Armboard cover on patient's right side only
- Clipping tabs by fenestration
- Clear side panel on patient's right side, 26½ x 63 in.
- Fenestration, oval with aperture incise, 4½ x 3½ in.

Tiburon® Femoral Angiography Drape with Dual Pouches

Cat. No.	Nonsterile No.	Qty. Cs
29521	29521N	10

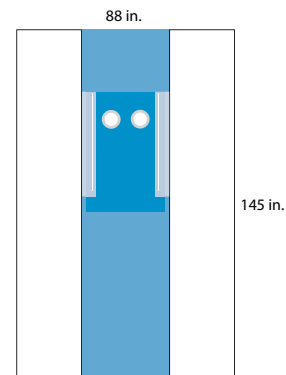

- Absorbent, impervious reinforcement, 32 x 50 in.
- Clear pouches on patient left and right side
- Clear side panels
- Fenestration, dual circular, 6 in., with circular incise aperture, 3½ in.



PICC Line Insertion Drape

Cat. No.	Nonsterile No.	Qty. Cs
29668	29668N	10

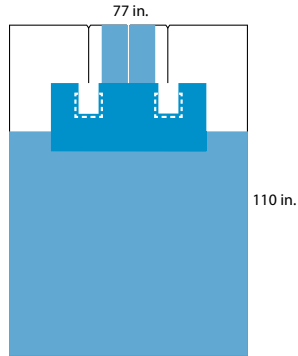

- Absorbent reinforcement, 52 x 27 in.
- Fenestration with adhesive, dual for right or left side line placement, 6 x 4 in.
- Notch at top center of drape allows user to create an opening to expose patient's face

Line Insertion Draping System

Cat. No.	Nonsterile No.	Qty. Cs
29559	29559N	10

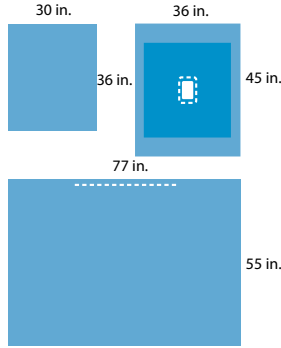

- Absorbent reinforcement, 30½ x 30½ in.
- Fenestration with adhesive, 4 x 6 in.
- Three-part draping system with prep pad, fenestrated drape and extension drape

Line Insertion Drape

Cat. No.	Nonsterile No.	Qty. Cs
N/A	29557N	

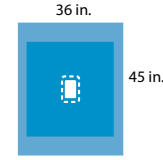

- Absorbent, impervious reinforcement, 30½ x 30½ in.
- Fenestration with adhesive, 4 x 6 in.

Full Body Central Line Insertion Drape

Cat. No.	Nonsterile No.	Qty. Cs
29322	29322N	10

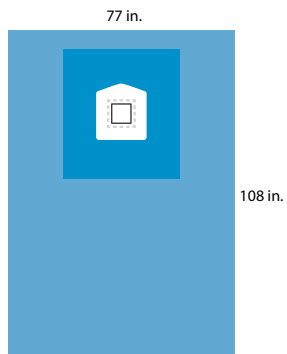

- Clear window, 18 x 18 in.
- Fenestration with adhesive, 6 x 6 in.
- Synthetic absorbent reinforcement, 41½ x 41½ in.

Femoral Angiography Drape with Single Pouch

Cat. No.	Nonsterile No.	Qty. Cs
29525	29525N	10

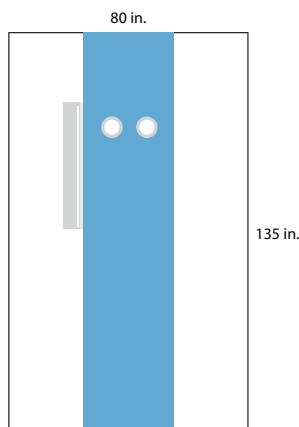

- Absorbent reinforcement, 36 x 135 in.
- Clear pouch on patient right side, 6 x 44 in.
- Clear side panels, 22 x 135 in.
- Fenestration, dual circular, 6 in., with circular incise aperture, 3½ in.

Full Body Central Line Drape

Cat. No.	Nonsterile No.	Qty. Cs
29527	29527N	14

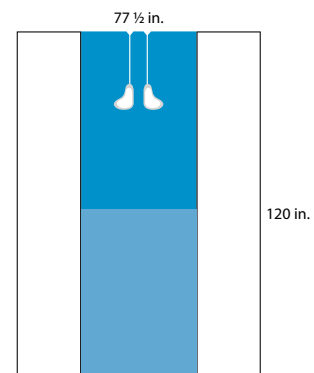

- Absorbent reinforcement, 36 x 57½ in.
- Fenestrations with incise aperture allow for intrajugular or subclavian access
- Clear side panels, 20¾ x 120 in.
- Easy removal feature on both fenestrations

Radial/Femoral Angiography Drape

Cat. No.	Nonsterile No.	Qty. Cs
29529	29529N	12

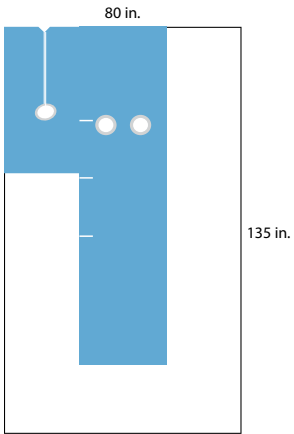

- Absorbent reinforcement
- Clear side and foot panels
- Fenestration, dual circular, 6 in., with circular incise aperture, 3½ in.
- Malleable bars
- Radial access on patient right, 2 x 3 in. oval incise aperture



Surgical Drapes and Packs

Cardiovascular



Tiburon® Cardiovascular Split Drape with Troughs

Cat. No.	Nonsterile No.	Qty. Cs
9158	9158N	8

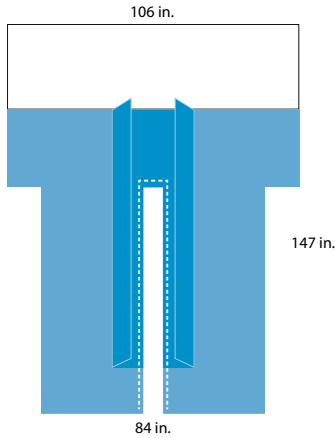

- Absorbent, impervious reinforcement
- Armboard covers
- Clear anesthesia screen
- Split with adhesive, 7 x 88 in.
- Instrument trough
- Included in pack 29158

Tiburon® Cardiovascular Split Drape with Pouches

Cat. No.	Nonsterile No.	Qty. Cs
9155	9155N	12

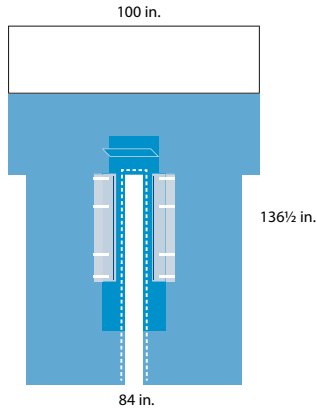

- Absorbent, impervious reinforcement, 10 x 57½ in. (sides) and 20 x 15 in. (top)
- Armboard covers
- Clear anesthesia screen, 100 x 28½ in.
- Clear pouches on patient right and left
- Clipping tab
- Split with adhesive, 7 x 81 in.

Tiburon® Cardiovascular Incise Drape

Cat. No.	Nonsterile No.	Qty. Cs
9156	9156N	7

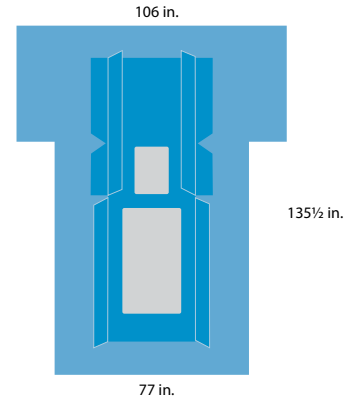

- Non-absorbent, impervious reinforcement
- Armboard covers
- Clipping tabs
- Fenestration, chest incise, 18 x 22 in.
- Fenestration, leg incise, 28 X 45 in.

Tiburon® Cardiovascular Split Drape

Cat. No.	Nonsterile No.	Qty. Cs
29154	29154N	8

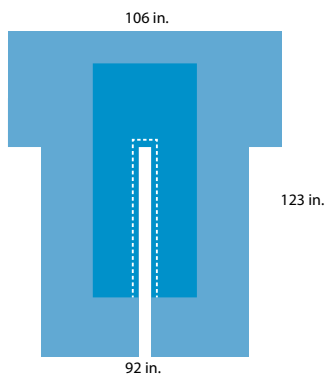

- Absorbent, impervious reinforcement
- Armboard covers
- Split with adhesive, 5 x 80 in.

Tiburon® Cardiovascular Peri-Groin Drape

Cat. No.	Nonsterile No.	Qty. Cs
9154	9154N	10

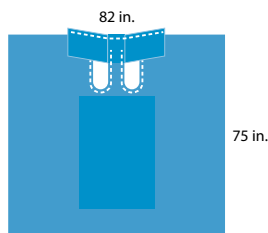

- Absorbent, impervious reinforcement, 30 x 42 in.
- Attached groin sheet, 36 x 11 in.
- Splits, dual with adhesive, 6 x 20 in.
- Included in pack 29158

Tiburon® Cardiovascular Incise Drape

Cat. No.	Nonsterile No.	Qty. Cs
9162	9162N	7

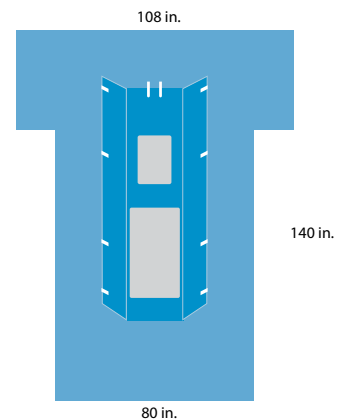

- Absorbent, impervious reinforcement, 42 x 88 in.
- Armboard covers
- Fenestration, chest incise, 14 x 18 in.
- Fenestration, leg incise, 24 x 41 in.
- Instrument troughs, 8 x 88 in.
- VELCRO® tabs

**Tiburon® Cardiovascular
 Drape**

Cat. No.	Nonsterile No.	Qty. Cs
N/A	9150N	

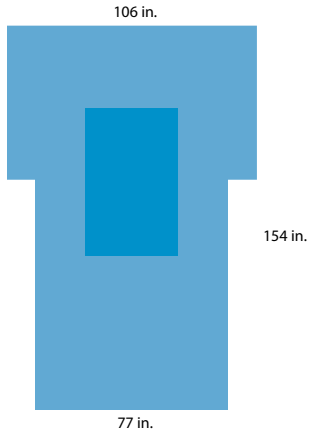

- Absorbent, foam reinforcement, 38½ x 60 in.
- Armboard covers
- Non-fenestrated

**Tiburon® Head, Side and
 Foot Drapes**

Cat. No.	Nonsterile No.	Qty. Cs
N/A	29462N	
N/A	29467N	
N/A	29468N	

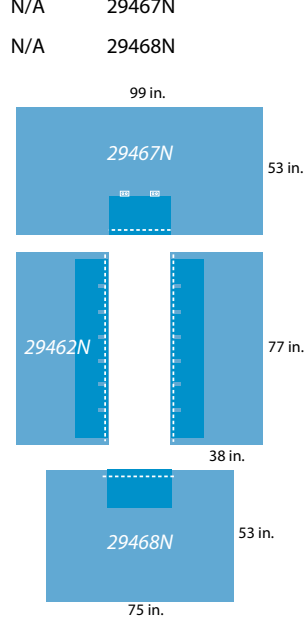

- Absorbent, impervious reinforcement
- Cord-holding tabs

**Tiburon® Bottom Drape
 with Reinforcement**

Cat. No.	Nonsterile No.	Qty. Cs
N/A	29464N	

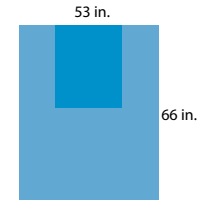

- Absorbent, impervious reinforcement, 26 x 30 in.

Cardiovascular

Cardiovascular Packs

Nonsterile No.	Description	9150 Cardiovascular Pack	29153 Cardiovascular Pack with impervious reinforced Gowns	29158 Cardiovascular Split Pack II
9150N	Tiburon® cardiovascular drape	1		
29467N	Tiburon® head drape, 99 x 53 in., adhesive, absorbent reinforcement		1	
29462N	Tiburon® side drape, 38 x 77 in., adhesive, absorbent reinforcement		2	
29468N	Tiburon® foot sheet, 75 x 53 in., adhesive, absorbent reinforcement		1	
9349N	Astound™ three-quarter drape sheet, 60 x 76 in.	1		1
9154N	Tiburon® cardiovascular peri-groin drape			1
9158N	Tiburon® cardiovascular split drape II			1
29464N	Tiburon® bottom drape with reinforcement		1	
9541N	Astound® gown, sterile back, fabric reinforced, X-large	3		
9040N	Astound® gown, poly reinforced, X-large		2	2
90780N	Astound® gown, impervious reinforced, X-large, with towel in outer wrap		1	
90680NA	Astound® gown, impervious reinforced, large, with towel in outer wrap			1
8520N	Absorbent towel	2	1	
7554N	Tiburon® drape towel, with adhesive strip, 19 x 30 in.			8
8694-60	Suture bag	1	1	1
8337N	Mayo stand cover, reinforced poly, 23 x 55 in.	1		1
8188N	Overhead table cover, 80 x 90 in., reinforced poly with a 44 x 72 in. fabric sterile field extension, SMS reinforcement, 40 x 90 in.		1	
8554N	Non-absorbent drape towel with adhesive strip, 15 x 26 in.	6	6	
9460N	Peri-towel		1	
8470N	Plastic sheet, 50 x 59 in.		1	
8152N	Heavy-duty back table cover, 80 x 110 in., SMS reinforcement, 37 x 110 in.			1
8143N	Standard back table cover, 50 x 90 in., SMS reinforcement, 29 x 90 in.	1	1	
	Quantity per case	4	3	3

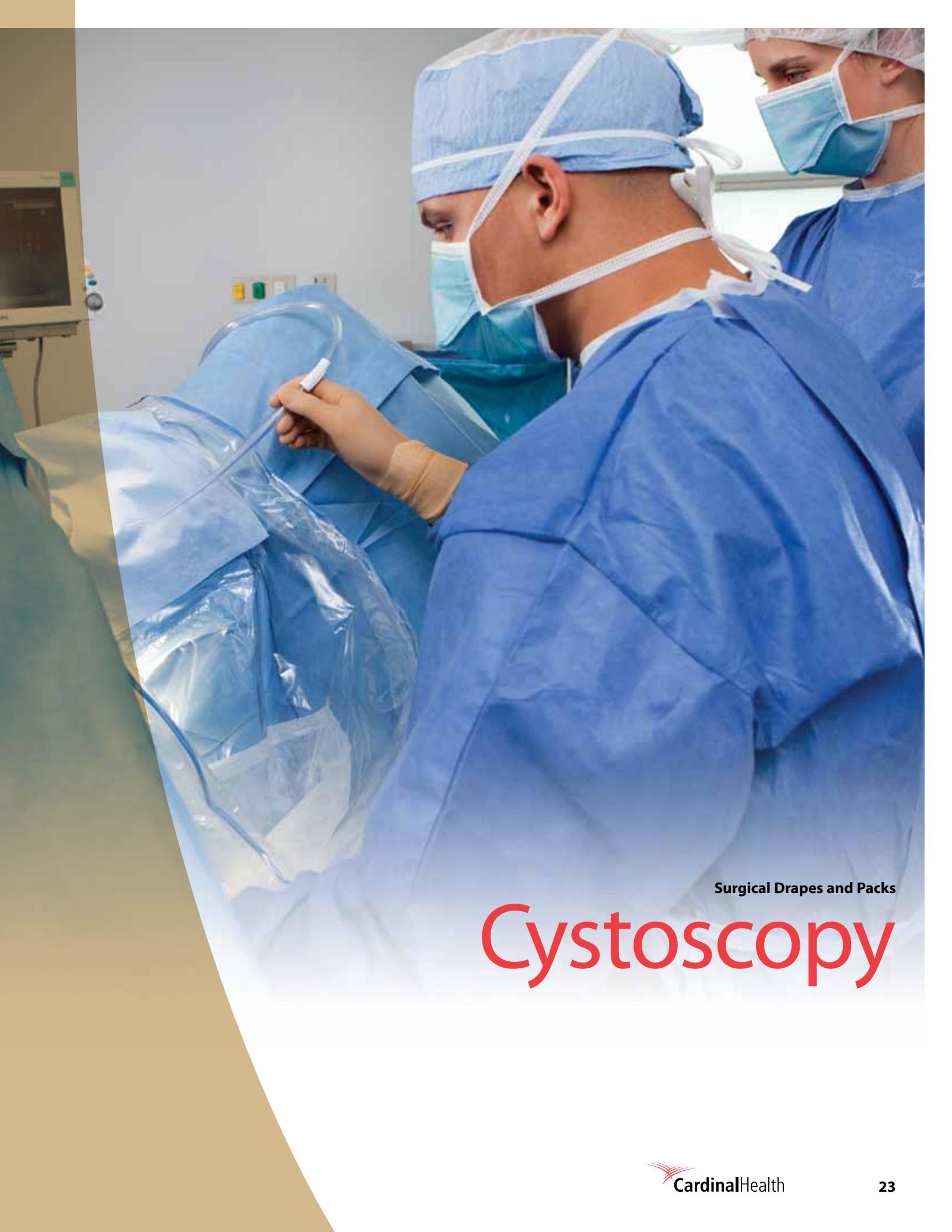

Surgical Drapes and Packs

Cystoscopy

Cystoscopy



Astound™ Cystoscopy “T” Drape

Cat. No.	Nonsterile No.	Qty. Cs
N/A	29437NA	

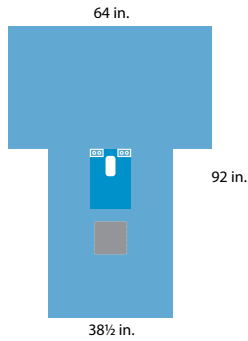

- Absorbent reinforcement, 12 x 21 in.
- Cord-holding tabs
- Fenestration, 3 x 6 in.
- Mesh screen, 10 x 10 in.
- Included in packs 29470, 29471, 29480

Astound™ Urological Drape

Cat. No.	Nonsterile No.	Qty. Cs
N/A	29451N	

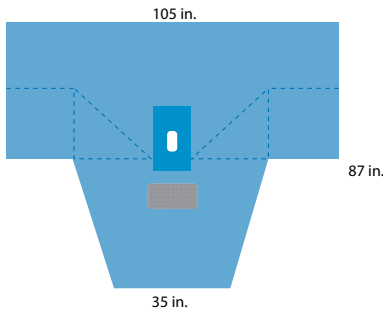

- Absorbent reinforcement, 12 x 19 in.
- Attached leggings
- Cord-holding tabs
- Fenestration, 3 x 6 in.
- Mesh screen, 14 x 8 in.
- Included in pack 29360

Astound™ Lithotomy Drape with Fluid Control Pouch

Cat. No.	Nonsterile No.	Qty. Cs
29455	29455NA	8

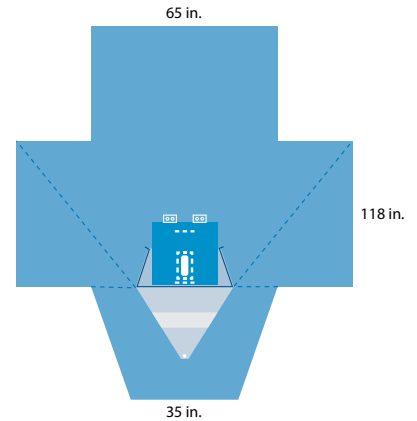

- Absorbent reinforcement, 20 x 19 in.
- Anesthesia screen
- Attached leggings
- Cord-holding tabs
- Fenestration with adhesive, 2½ x 6½ in.
- Fluid control pouch with filtering screen, suction port, drawstring feature and side trough
- Mesh screen, 20 x 6 in.

Cystoscopy Packs

Nonsterile No.	Description	29470 Cystoscopy Pack	29471 Cystoscopy Pack	29480 Cystoscopy Pack	29360 Cystoscopy Pack	9520E Cystoscopy Pack
29437NA	Cysto “T” drape, absorbent reinforcement	1	1	1		
29451N	Urological drape with absorbent reinforcement, attached leggings				1	
9461N	Astound™ drape sheet, square-folded, 38½ x 38½ in.					2
9515NA	Astound® standard gown, sterile back, large	1				
32474N	SmartGown™, X-large, X-long, specialty surgical gown		1			
8694-60	Suture bag	1	1	1	1	1
8520N	Absorbent towel	1	1	1	1	
8421N	Pair of leggings, X-large	1	1	1		1
8145N	Outer wrap/reinforced poly table cover 44 x 75 in., reinforcement 24 x 75 in.	1	1	1	1	1
Quantity per case		10	8	14	10	10

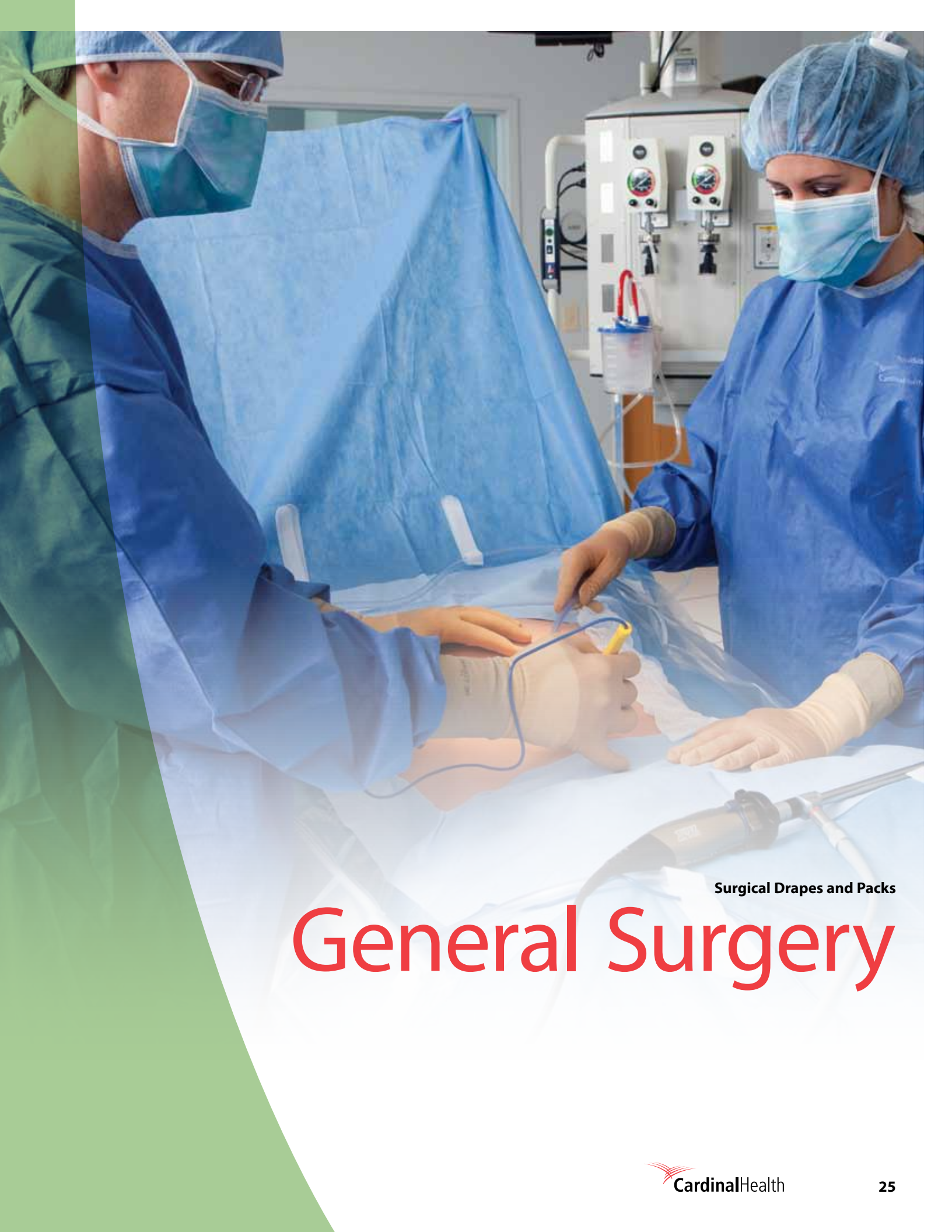

Surgical Drapes and Packs

General Surgery

General Surgery

Setup Packs

Nonsterile No.	Description	114 Setup Pack	117 Setup Pack	119 Orthopedic Setup Pack	9102 Basic Pack
8554N	Drape towel, adhesive, nonabsorbent		4	4	
8337N	Mayo Stand Cover, reinforced poly, 23" wide	1	1	1	1
8694-60	Suture bag	1	1	1	1
8476NA	U-Drape, poly, adhesive, 60" x 72", 6" x 21" split			1	
1582N	Stockinette, 12" x 48", X-large			1	
3524N	Drape Tape			4	
8146N	Outer wrap, reinforced poly table cover, 44" x 90"	1			
8143N	Outer wrap, reinforced poly table cover, 50" x 90"		1		
8186N	Outer wrap, reinforced poly table cover, 65" x 90", heavy-duty			1	1
Quantity per case		12	13	4	12

Basic Packs

Nonsterile No.	Description	9100 Basic Pack	9101 Basic Pack	9103 Basic Pack	9109 Basic Pack	9111 Basic Pack	9112 Basic Pack	9113 Basic Pack	9114 Basic Pack	9131 Basic Pack
8520N	Absorbent towel					1		1	1	
8694-60	Suture bag	1	1	1	1	1	1	1	1	1
8337N	Mayo stand cover, reinforced poly, 23 in. wide	1	1	1	1	1	1	1	1	1
8554N	Drape towel, adhesive, nonabsorbent	4		4		4	4	4	4	
9358N	Astound™ fan-folded drape sheet, 44 x 57 in.	1		1						
9349N	Astound™ fan-folded drape sheet, 60 x 76 in.	1		1	1	1	1	1	1	
90270NA	Astound® standard scrub nurse gown with towel in outer wrap, large		1	1				1		1
9515NA	Astound® standard gown, sterile back, large		1	1				1		1
90970N	Astound® scrub nurse gown with towel in outer wrap, fabric-reinforced, large					1				
9511N	Astound® gown, sterile back, fabric reinforced, large					1				
9010N	Astound® impervious reinforced gown, large									1
90680NA	Astound® impervious reinforced gown with towel in outer wrap, large									1
8143N	Outer wrap, reinforced poly table cover, 50 x 90 in.				1					1
8146N	Outer wrap, reinforced poly table cover, 44 x 90 in.	1	1	1		1	1	1		
8186N	Outer wrap, reinforced poly table cover, 65 x 90 in., heavy-duty									1
Quantity per case		12	5	8	10	5	10	5	5	7



Tiburon® Head, Side and Foot Drape

Cat. No.	Nonsterile No.	Qty. Cs
N/A	9467N	
N/A	9465N	
N/A	9468N	

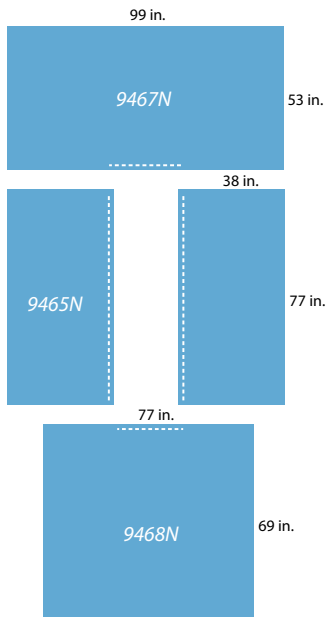

- Included in pack 9106

Tiburon® Universal Pack

Cat. No.	Nonsterile No.	Qty. Cs
N/A	29467N	
N/A	29465NA	
N/A	29469N	

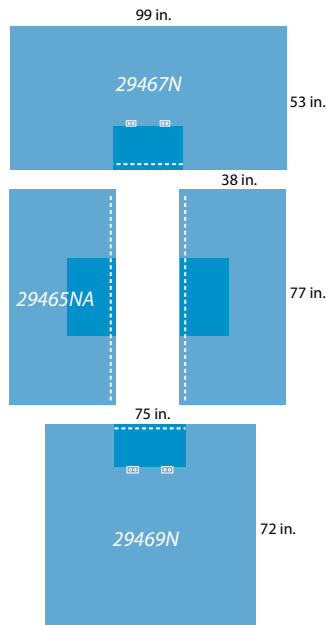

- Absorbent, impervious reinforcement with adhesive
- Cord-holding tabs
- Included in pack 29107

Tiburon® Universal Pack

Cat. No.	Nonsterile No.	Qty. Cs
N/A	29667N	
N/A	29665N	
N/A	29669N	

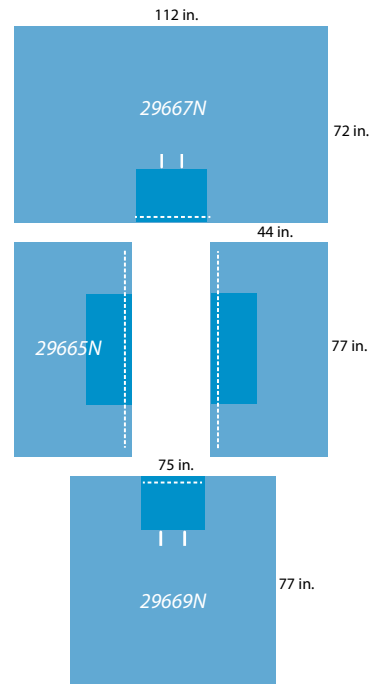

- Absorbent, impervious reinforcement with adhesive
- Cord-holding straps
- Included in pack 29118

Tiburon® Universal Split Pack

Cat. No.	Nonsterile No.	Qty. Cs
29352	29351N	14
29440	29440NA	10

- Absorbent, impervious reinforcement
- Cord-holding tabs
- Split, 6 x 46 in. (29440NA)
- Instrument pad (29351N)
- Included in pack 29131

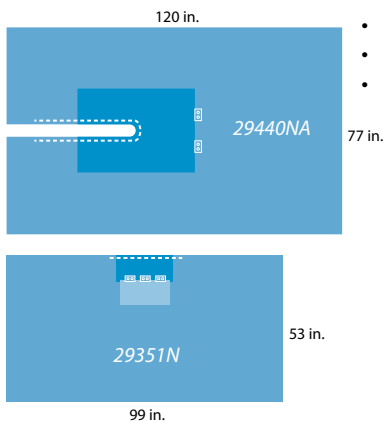

Tiburon® Universal Split Pack

Cat. No.	Nonsterile No.	Qty. Cs
N/A	29195N	
N/A	29194N	

- Absorbent, impervious reinforcement
- Cord-holding tabs
- Split, 12 x 30 in. (29194N)
- Included in pack 29133

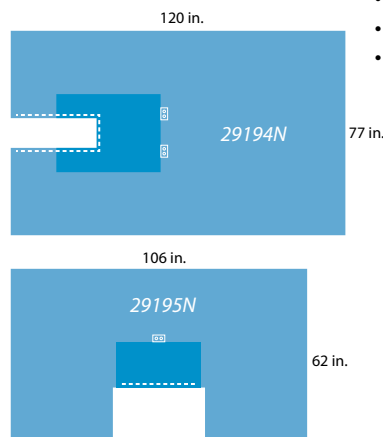

General Surgery

Universal Packs

Nonsterile No.	Description	9106 Universal Pack	29107 Universal Pack	29118 Universal Pack	29131 Universal Split Pack	29133 Universal Split Pack II
9465N	Tiburon® side drape, 38 x 77 in., adhesive	2				
9468N	Tiburon® foot drape, 77 x 69 in., adhesive	1				
9467N	Tiburon® head drape, 99 x 53 in., adhesive	1				
29465NA	Tiburon® side drape, 38 x 77 in., adhesive, absorbent reinforcement		2			
29469N	Tiburon® foot drape, 75 x 72 in., adhesive, absorbent reinforcement		1			
29467N	Tiburon® head drape, 99 x 53 in., adhesive, absorbent reinforcement		1			
29440NA	Tiburon® split drape with absorbent reinforcement				1	
29351N	Tiburon® top drape, absorbent reinforcement, instrument pad				1	
29669N	Tiburon® foot drape, 75 x 77 in., adhesive, absorbent reinforcement			1		
29667N	Tiburon® head drape, 112 x 72 in., adhesive, absorbent reinforcement			1		
29665N	Tiburon® side drape, 44 x 77 in., adhesive, absorbent reinforcement			2		
29194N	Tiburon® chest/breast drape					1
29195N	Tiburon® bar drape with armboard covers					1
90270NA	Astound® standard scrub nurse gown with towel in outer wrap, large		1			
9515NA	Astound® standard gown, sterile back, large		1			
8520N	Absorbent towel	1	1	1		
8554N	Drape towel, adhesive, nonabsorbent		4	4	4	4
8337N	Mayo stand cover, reinforced poly, 23 in. wide	1	1	1	1	1
8694-60	Suture bag	1	1	1	1	1
8146N	Outer wrap, reinforced poly table cover, 44 x 90 in.	1	1	1		
8143N	Outer wrap, reinforced poly table cover, 50 x 90 in.				1	1
	Quantity per case	5	6	6	4	10



Tiburon® Laparotomy Drape

Cat. No.	Nonsterile No.	Qty. Cs
29410	29410N	12

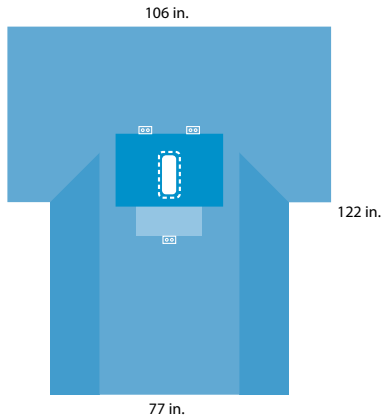

- Absorbent, impervious reinforcement, 30½ x 24 in.
- Armboard covers
- Cord-holding tabs
- Fenestration, 4 x 12 in.
- Instrument pad
- Included in packs 29127, 29130, 29136, 29137, 29138, 29140

Tiburon® Laparotomy Drape

Cat. No.	Nonsterile No.	Qty. Cs
29411	N/A	9

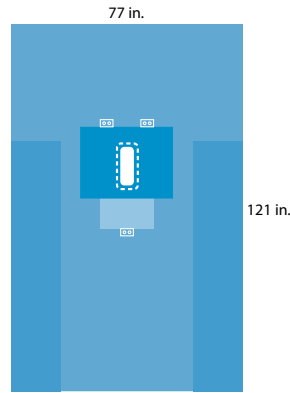

- Absorbent, impervious reinforcement, 30½ x 24 in.
- Cord-holding tabs
- Fenestration, 4 x 12 in.
- Instrument pad
- Included in pack 29120

Tiburon® Transverse Laparotomy Drape

Cat. No.	Nonsterile No.	Qty. Cs
29421	29421N	12

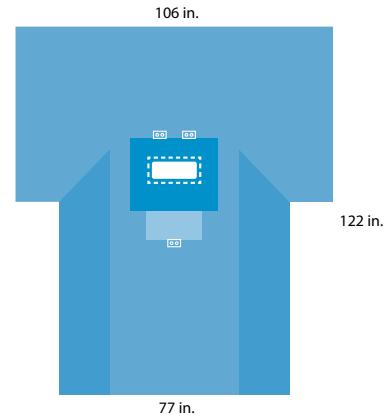

- Absorbent, impervious reinforcement, 30½ x 24 in.
- Armboard covers
- Cord-holding tabs
- Fenestration, 14 x 4 in.
- Instrument pad
- Included in pack 29121

Tiburon® Pfannenstiel Laparotomy Drape

Cat. No.	Nonsterile No.	Qty. Cs
29425	N/A	8

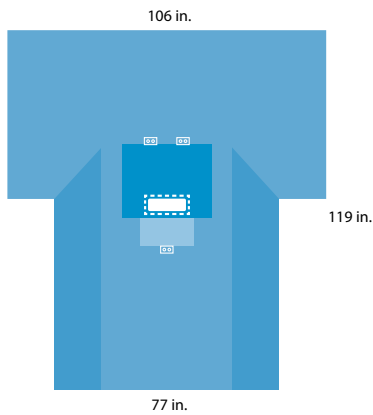

- Absorbent, impervious reinforcement, 30½ x 23 in.
- Armboard covers
- Cord-holding tabs
- Fenestration, 12 x 3 in.
- Instrument pad

Tiburon® Laparotomy Incise Drape

Cat. No.	Nonsterile No.	Qty. Cs
29510	29510N	14

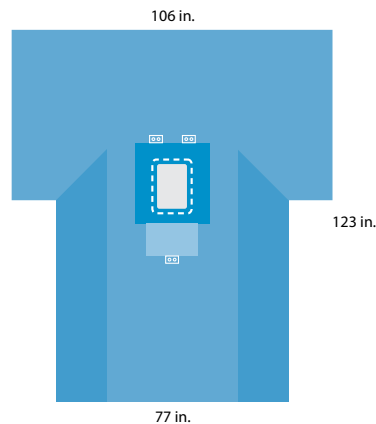

- Absorbent, impervious reinforcement, 22 x 26 in.
- Armboard covers
- Cord-holding tabs
- Fenestration, full incise, 9 x 14½ in.
- Instrument pad

Tiburon® Laparotomy Drape with Pouches

Cat. No.	Nonsterile No.	Qty. Cs
9430	9430N	12

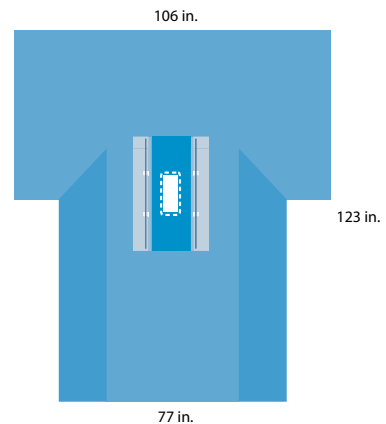

- Absorbent, impervious reinforcement, 14 x 38½ in.
- Armboard covers
- Dual clear closed end poly troughs with VELCRO® closures, 8 x 38½ in.
- Fenestration, 4 x 12 in.

General Surgery

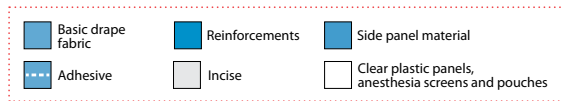

Tiburon® Laparotomy Drape with Pouches

Cat. No.	Nonsterile No.	Qty. Cs
9412	9412N	14

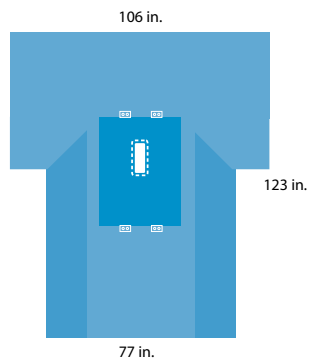

- Absorbent, impervious reinforcement, 34 x 44 in.
- Armboard covers
- Cord-holding tabs
- Fenestration, 4 x 12 in.

Astound™ Minor Procedure Drape

Cat. No.	Nonsterile No.	Qty. Cs
29496	29496N	10

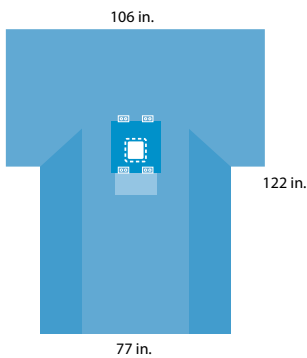

- Absorbent, reinforcement, 19 x 19 in.
- Armboard covers
- Cord-holding tabs
- Fenestration, 6 x 6 in.
- Instrument pad

Tiburon® General Surgery Drape

Cat. No.	Nonsterile No.	Qty. Cs
29499	29499N	10

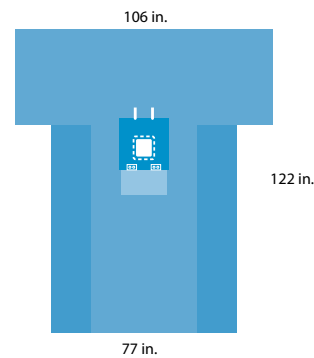

- Absorbent, impervious reinforcement, 19 x 20 in.
- Armboard covers
- Fenestration, 6 x 6 in.
- Instrument pad
- VELCRO® cord-holding tabs

Astound™ Adolescent Laparotomy Drape

Cat. No.	Nonsterile No.	Qty. Cs
9418	9418N	10

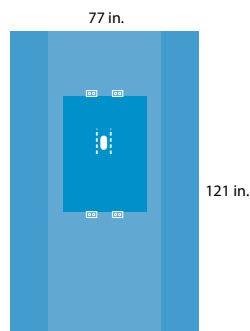

- Absorbent, reinforcement, 35 x 44 in.
- Cord-holding tabs
- Fenestration, 2½ x 5½ in.

Tiburon® Thyroid Drape

Cat. No.	Nonsterile No.	Qty. Cs
29522	29522N	12

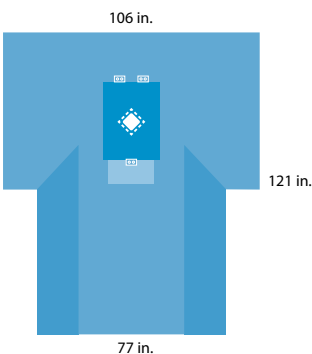

- Absorbent, impervious reinforcement, 23½ x 30 in.
- Armboard covers
- Cord-holding tabs
- Fenestration, diamond, 5 x 5 in.
- Instrument pad

Tiburon® Thyroid Drape

Cat. No.	Nonsterile No.	Qty. Cs
29422	29422N	10

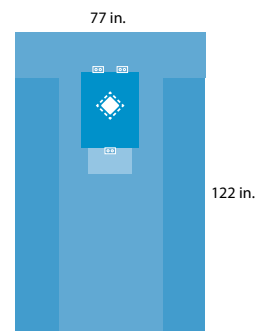

- Absorbent, impervious reinforcement, 22 x 30 in.
- Cord-holding tabs
- Fenestration, diamond, 5 x 5 in.
- Instrument pad

Tiburon® Chest/Breast Drape

Cat. No.	Nonsterile No.	Qty. Cs
29420	29420N	12

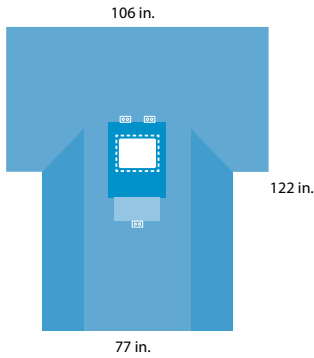

- Absorbent, impervious reinforcement, 22 x 30 in.
- Armboard covers
- Cord-holding tabs
- Fenestration, 14 x 11 in.
- Instrument pad

Tiburon® Laparoscopic Cholecystectomy Drape with Pouches

Cat. No.	Nonsterile No.	Qty. Cs
9428	9428NA	8

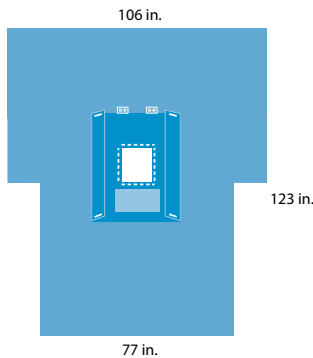

- Absorbent, impervious reinforcement, 36 x 42 in.
- Armboard covers
- Cord-holding tabs
- Fabric pouches with adhesive, 10 x 42 in.
- Fenestration, offset 5 in., 11 x 14 in.
- Instrument pad

Tiburon® Laparoscopic Abdominal Drape

Cat. No.	Nonsterile No.	Qty. Cs
9438	9438N	12

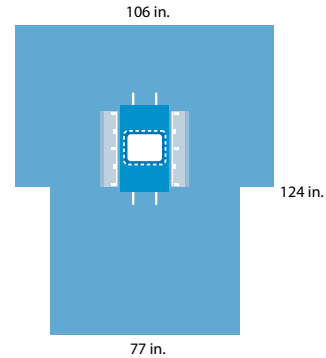

- Absorbent, impervious reinforcement, 20 x 35½ in.
- Armboard covers
- Fenestration, 14 x 11 in.
- Two (2) separate clear pouches on each side, 10½ x 30 in., feature a shared malleable wire
- VELCRO® cord-holding tabs

Tiburon® General Endoscopy Drape

Cat. No.	Nonsterile No.	Qty. Cs
9458	9458N	12

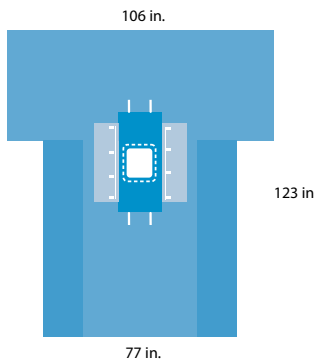

- Absorbent, impervious reinforcement, 16 x 38½ in.
- Armboard covers
- Dual clear open ended poly troughs with VELCRO® closure, 11½ x 30 in.
- Fenestration, 10 x 11 in.
- VELCRO® cord-holding tabs
- Included in pack 9120

Tiburon® Bariatric Drape

Cat. No.	Nonsterile No.	Qty. Cs
94590	94590N	8

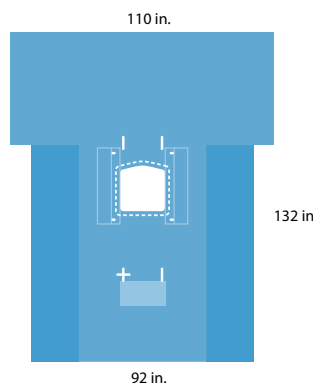

- Armboard covers
- Fabric instrument troughs, 28½ x 24 in.
- Fenestration, chevron, 18 x 18 in.
- Instrument pad
- VELCRO® cord-holding tabs

Tiburon® Major Abdominal Drape with Pouches

Cat. No.	Nonsterile No.	Qty. Cs
9457	9457N	12

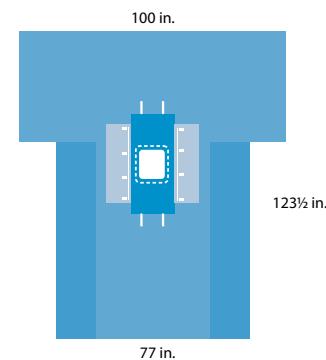

- Absorbent, impervious reinforcement, 16 x 38½ in.
- Armboard covers
- Dual clear pouches with VELCRO® closure, 11½ x 30 in.
- Fenestration, 10 x 11 in.
- VELCRO® cord-holding tabs

General Surgery

Laparotomy Packs

Nonsterile No.	Description	29127 Laparotomy Pack	29130 Laparotomy Pack	29136 Laparotomy Pack	29137 Laparotomy Pack	29138 Laparotomy Pack	29140 Laparotomy Pack	29120 Laparotomy Pack	29121 Transverse Laparotomy Pack	9135 Laparotomy Pack	9139 Laparotomy Pack
9358N	Astound™ half drape, 44 x 57 in.	2		1				2			
29410N	Tiburion® laparotomy drape, absorbent reinforcement	1	1	1	1	1	1				
29411N	Tiburion® laparotomy drape, absorbent reinforcement							1			
29421N	Tiburion® laparotomy drape, absorbent reinforcement								1		
9412N	Tiburion® laparotomy drape with pouches									1	1
90680NA	Astound® gown, impervious reinforced, large with towel in outer wrap		1								
9010N	Astound® impervious reinforced gown, large		1								
90270NA	Astound™ standard scrub nurse gown with towel in overwrap, large						1	1			
9515NA	Astound® standard gown, sterile back, large						1	1			2
9511N	Astound® gown, sterile back, fabric reinforced, large	2			2						
8554N	Drape towel, adhesive, nonabsorbent	4	4	4	4	4	4	4	4	4	4
8520N	Absorbent towel	3	1	1	2	1		1	1	1	2
8337N	Mayo stand cover, reinforced poly, 23 in. wide	1	1	1	1	1	1	1	1	1	1
8694-60	Suture bag	1	1	1	1	1	1	1	1	1	1
8146N	Outer wrap, reinforced poly table cover, 44 x 90 in.	1			1	1	1	1	1	1	1
8143N	Outer wrap, reinforced poly table cover, 50 x 90 in.		1	1							
	Quantity per case	6	4	5	6	10	4	5	6	10	6

General Endoscopy Pack

Nonsterile No.	Description	9120 General Endoscopy Pack
9458N	Tiburion® general endoscopy drape	1
90270NA	Astound® standard scrub nurse gown with towel in overwrap, large	1
9515NA	Astound® standard gown, sterile back, large	1
8554N	Drape towel, adhesive, nonabsorbent	4
7148N	X-ray detectable sponge, 4 x 4 in.	10
8337N	Mayo stand cover, reinforced poly, 23 in. wide	1
8694-60	Suture bag	1
8146N	Outer wrap, reinforced poly table cover, 44 x 90 in.	1
	Quantity per case	6



Surgical Drapes and Packs

Neurology



Tiburon® Craniotomy Drape

Cat. No.	Nonsterile No.	Qty. Cs
9450	9450N	7

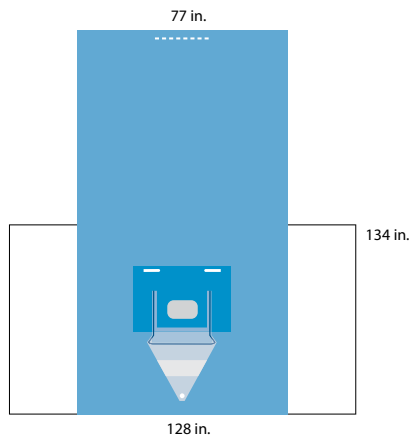

- Absorbent, impervious reinforcement, 35 x 22 in.
- Clear anesthesia panels
- Fenestration, oval with full incise, 11 x 7 in.
- Fluid control drawstring pouch with screen and port
- VELCRO® cord-holding tabs

Tiburon® Neurological Drape

Cat. No.	Nonsterile No.	Qty. Cs
9448	9448N	8

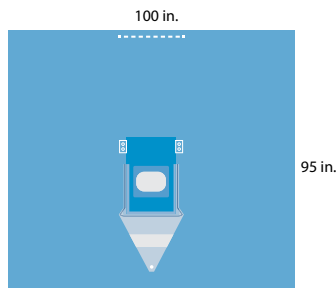

- Absorbent, impervious reinforcement, 18½ x 28½ in.
- Cord-holding tabs
- Fenestration, oval with full incise, 11 x 7 in.
- Fluid control drawstring pouch with screen and port, 20½ x 40 in.

Tiburon® Neurological Drape

Cat. No.	Nonsterile No.	Qty. Cs
9449	9449N	8

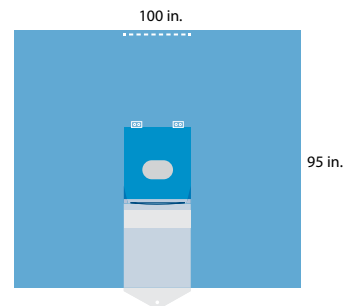

- Absorbent, impervious reinforcement, 35 x 28 in.
- Cord-holding tabs
- Extra-large fluid control drawstring pouch with screen and port
- Fenestration, oval with full incise, 11 x 7 in.

Tiburon® Universal Spine Drape

Cat. No.	Nonsterile No.	Qty. Cs
29418	29418N	7

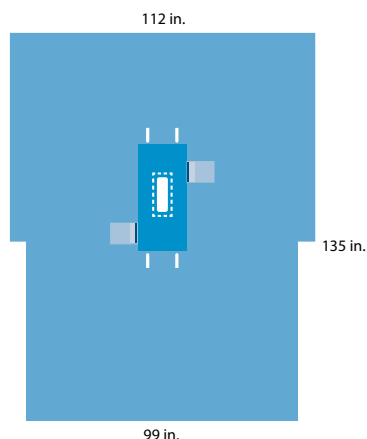

- Absorbent, impervious reinforcement, 17 x 37 in.
- Armboard covers
- Fenestration, 4 x 12 in.
- Instrument pouches, 7½ x 12 in.
- VELCRO® cord-holding tabs

Tiburon® Craniotomy Split Drape

Cat. No.	Nonsterile No.	Qty. Cs
9439	9439N	8

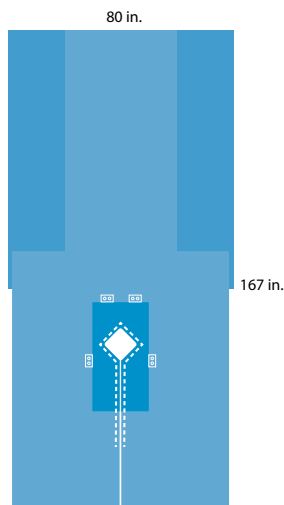

- Absorbent, impervious reinforcement, 20 x 38 in.
- Attached overhead table cover, 80 x 90 in.
- Cord-holding tabs
- Fenestration, diamond, 8 x 8 in.
- Split, 54 in.

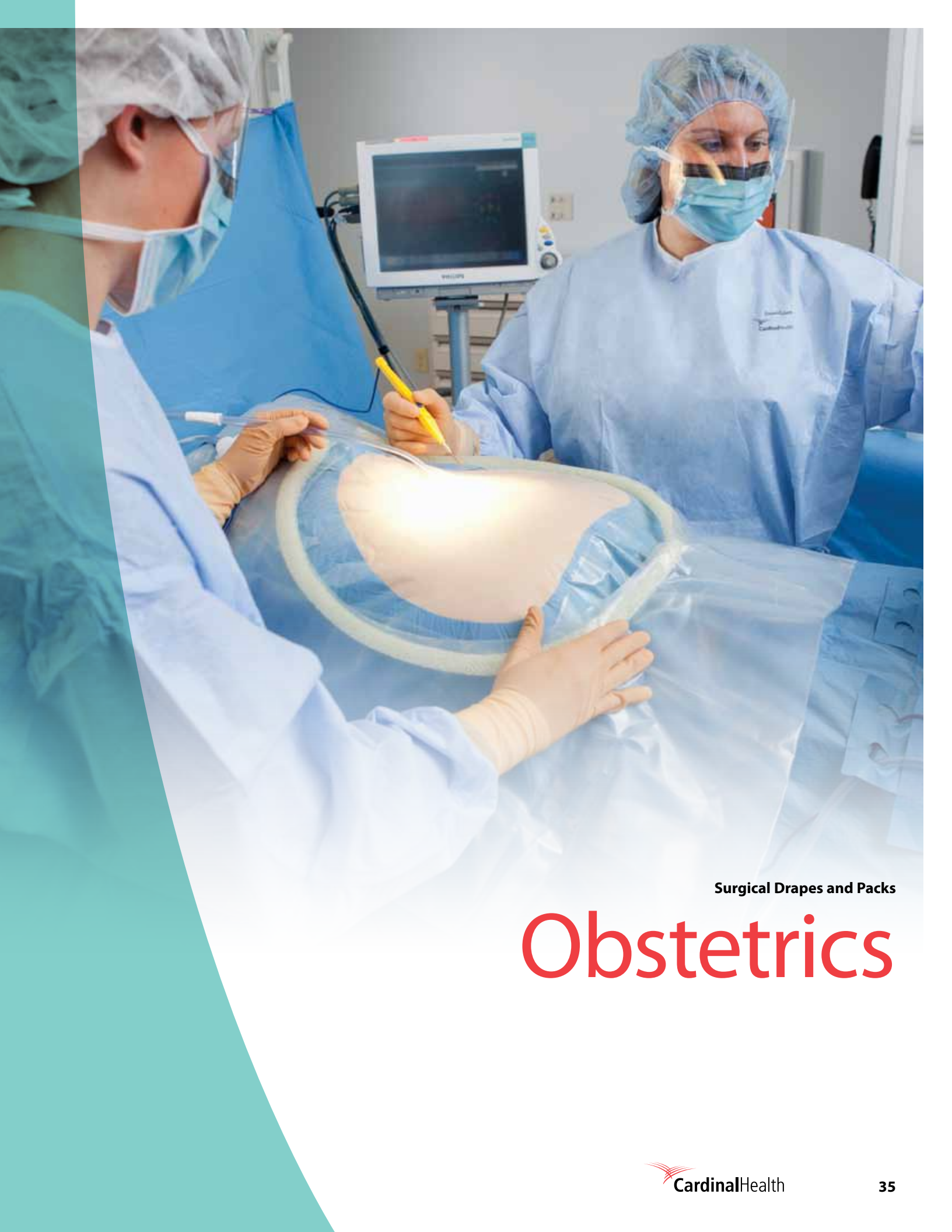

Surgical Drapes and Packs

Obstetrics

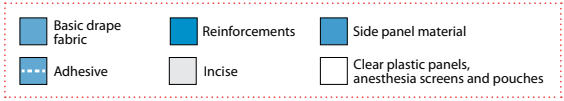

Tiburon® Cesarean Birth Drape

Cat. No.	Nonsterile No.	Qty. Cs
29449	29449N	7

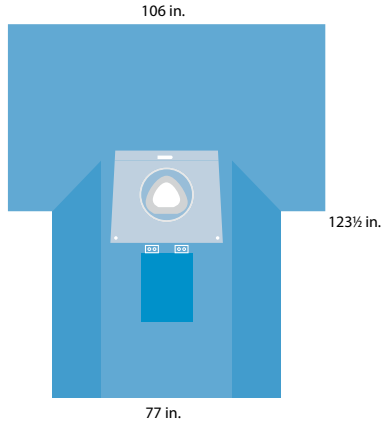

- 360-degree fluid control pouch with contoured foam ring, VELCRO® cord-holding tab and ports
- Armboard covers
- Fenestration, circular with 2 in. incise aperture, 16 in.
- Reinforcement, 17 x 22 in.
- Cord-holding tabs

Tiburon® Cesarean Birth Drape

Cat. No.	Nonsterile No.	Qty. Cs
29443	29443N	7

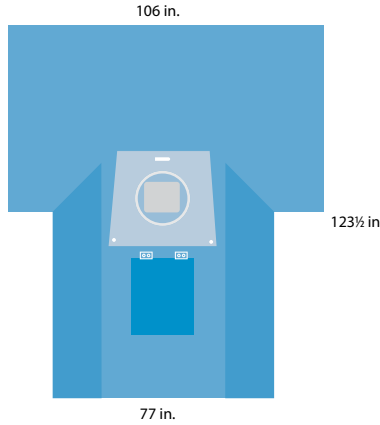

- 360-degree fluid control pouch with contoured foam ring, VELCRO® cord-holding tab and ports
- Armboard covers
- Fenestration, full incise, 9 x 14 in.
- Reinforcement, 17 x 22 in.
- Cord-holding tabs

Tiburon® Cesarean Birth Drape

Cat. No.	Nonsterile No.	Qty. Cs
29448	29448N	7

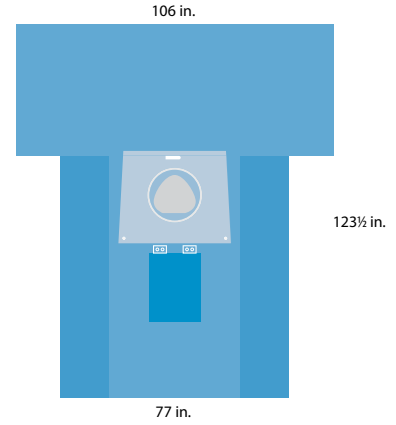

- 360-degree fluid control pouch with contoured foam ring, VELCRO® cord-holding tab and ports
- Armboard covers
- Cord-holding tabs
- Fenestration, pear-shaped with full incise, 12 x 14 in.
- Reinforcement, 17 x 22 in.

Tiburon® Cesarean Birth Drape

Cat. No.	Nonsterile No.	Qty. Cs
29452	29452N	8

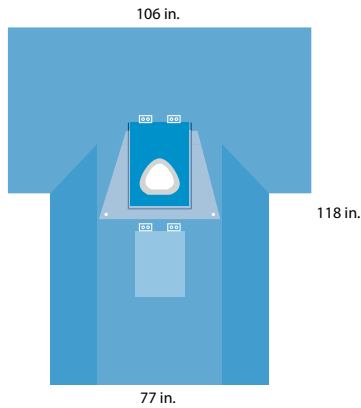

- 270-degree fluid control pouch with malleable wire
- Armboard covers
- Cord-holding tabs
- Fenestration, pear-shaped with 2 in. incise aperture, 12 x 14 in.
- Reinforcement around fenestration (20 3/8 x 27 in.) and below pouch (17 x 22 in.)

Tiburon® Cesarean Birth Drape

Cat. No.	Nonsterile No.	Qty. Cs
29447	29447N	8

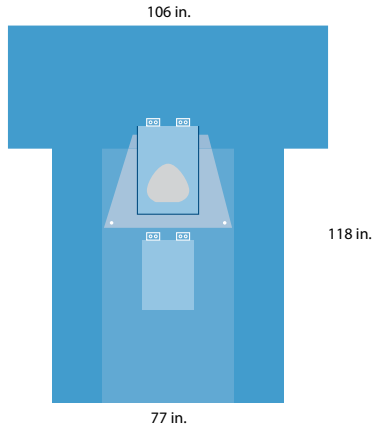

- 270-degree fluid control pouch with malleable wire and ports
- Armboard covers
- Cord-holding tabs
- Fenestration, pear-shaped with full incise, 12 x 14 in.
- Reinforcement around fenestration (20 3/8 x 27 in.) and below pouch (17 x 22 in.)

Tiburon® Cesarean Birth Drape

Cat. No.	Nonsterile No.	Qty. Cs
N/A	29453N	

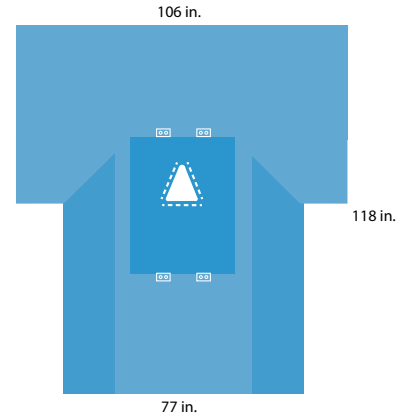

- Armboard covers
- Cord-holding tabs
- Fenestration, triangular with adhesive, 12 x 10 1/2 in.
- Reinforcement, 30 1/2 x 37 in.

Astound™ Abdominal Cover

Cat. No.	Nonsterile No.	Qty. Cs
N/A	29357N	

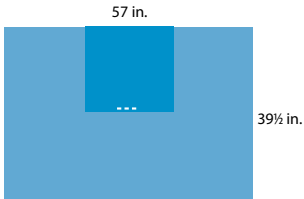

- Absorbent reinforcement, 19 x 19 in.
- Included in pack 29920

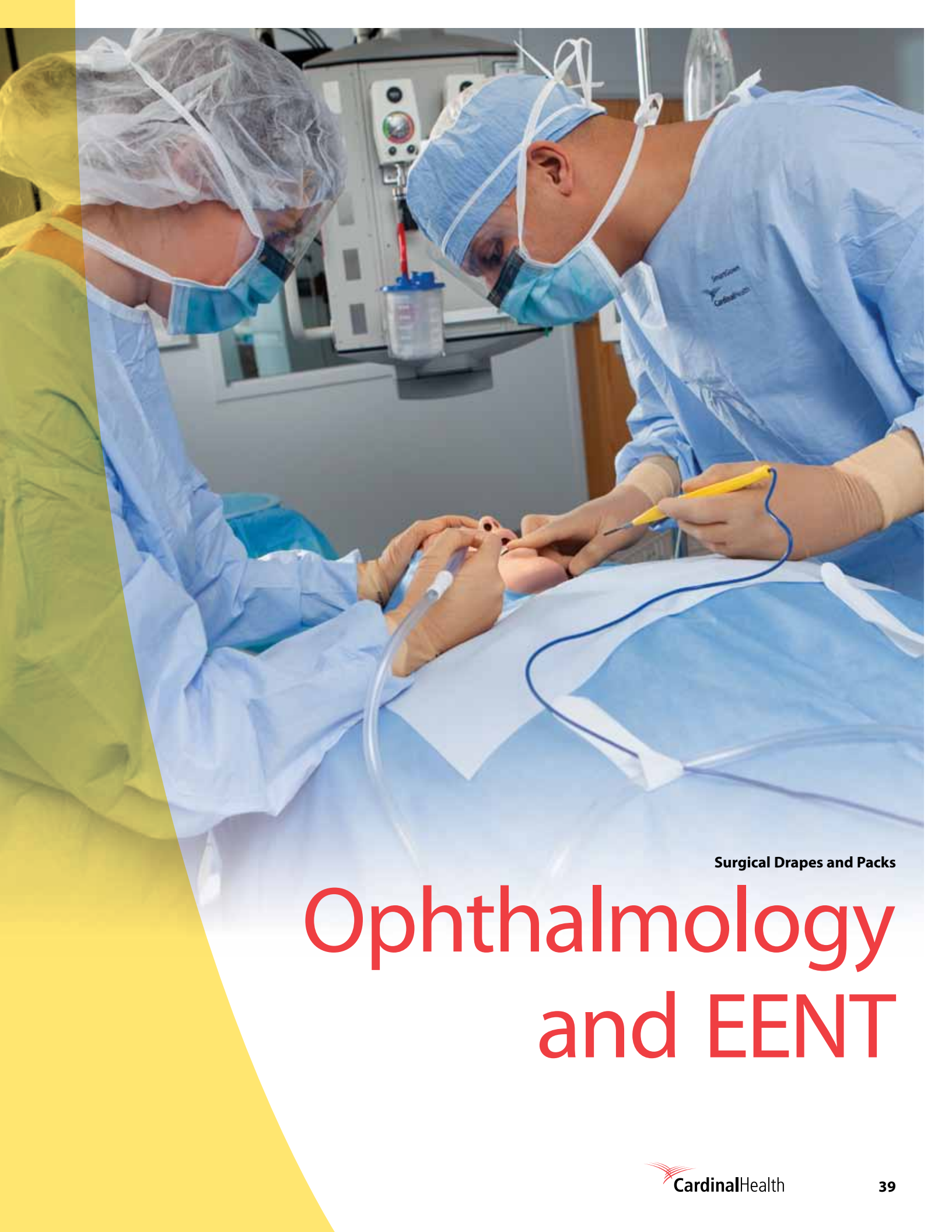

Obstetrical Pack

Nonsterile No.	Description	29920 Obstetrical Pack
29357N	Astound® abdominal cover	1
8421N	Pair of leggings, X-large	1
8483N	Under-buttocks drape, reinforced poly	1
8365N	Setup cover, 44 x 71 in.	1
8520N	Absorbent towel	2
8145N	Outer wrap/reinforced poly table cover 44 x 75 in., reinforcement 24 x 75 in.	1
Quantity per case		6



Surgical Drapes and Packs

Ophthalmology and EENT

 Basic drape fabric	 Reinforcements	 Side panel material
 Adhesive	 Incise	 Clear plastic panels, anesthesia screens and pouches

Eysescape® Refractive Drape

Cat. No.	Nonsterile No.	Qty. Cs
N/A	ES5000N	7

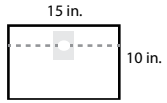

- Clear film drape
- Oval incise aperture, 1¾ x 1½ in.

Eysescape® Small Drape with Adhesive Aperture

Cat. No.	Nonsterile No.	Qty. Cs
N/A	ES5020N	

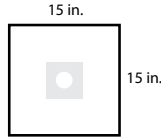

- Circular incise aperture, 2¾ in.
- Clear film drape

Eysescape® Medium Drape with Adhesive Aperture

Cat. No.	Nonsterile No.	Qty. Cs
N/A	ES5030N	

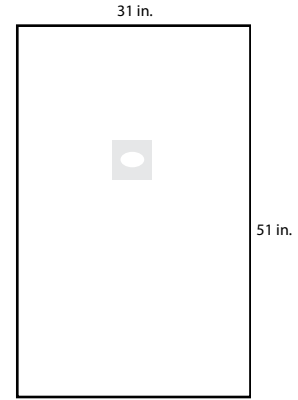

- Clear film drape
- Oval incise aperture, 2 x 2⅞ in.

Eysescape® Small Drape with Adhesive Aperture and Pouch

Cat. No.	Nonsterile No.	Qty. Cs
N/A	ES5040N	

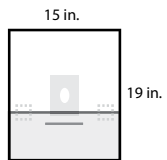

- Clear film drape
- Fluid collection pouch with flexible strip and adhesive tabs
- Oval incise aperture, 1¾ x 2¾ in.

Eysescape® Medium Drape with Wide Adhesive Aperture

Cat. No.	Nonsterile No.	Qty. Cs
N/A	ES5300N	

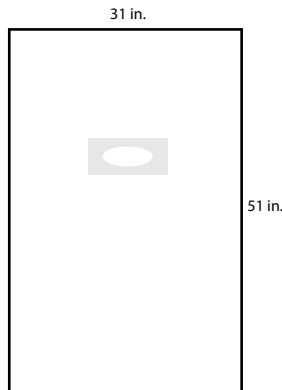

- Clear film drape
- Wide elliptical incise aperture, 6⅞ x 2⅞ in.

Eysescape® Small Drape with Incise Film

Cat. No.	Nonsterile No.	Qty. Cs
N/A	ES5010N	

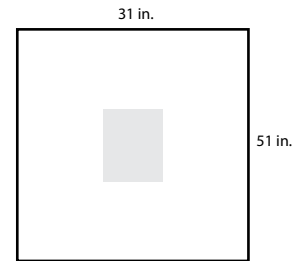

- Clear film drape
- Full incise, 3⅞ x 4⅞ in.

Ophthalmology and EENT

Eyscape® Medium Drape with Incise Film Pouch

Cat. No.	Nonsterile No.	Qty. Cs
N/A	ES5500N	

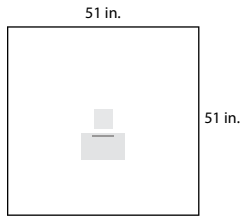

- Clear film drape
- Fluid collection pouch with malleable strip
- Full incise, 3 $\frac{7}{8}$ x 4 $\frac{7}{8}$ in.

Eyscape® Medium Drape with Incise Film

Cat. No.	Nonsterile No.	Qty. Cs
N/A	ES6000N	

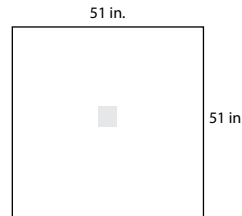

- Clear film drape
- Full incise, 3 $\frac{7}{8}$ x 4 $\frac{7}{8}$ in.

Eyscape® Ophthalmic Drape

Cat. No.	Nonsterile No.	Qty. Cs
7444	7444N	10

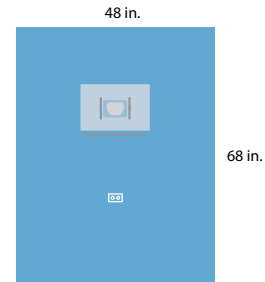

- Cord-holding tab
- Dual saddlebag fluid control pouches with malleable strips
- Full incise, 4 x 5 in.
- Malleable breather-bar
- SMS material

Eyscape® Ophthalmic Drape

Cat. No.	Nonsterile No.	Qty. Cs
7445	7445N	10

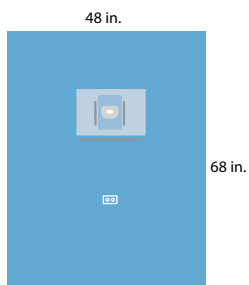

- Dual saddlebag fluid control pouches with malleable strips
- Malleable breather-bar
- Oval incise aperture, 1 $\frac{1}{2}$ x 2 $\frac{1}{2}$ in.
- Cord-holding tab
- SMS material

Eyscape® ClearView Eye Drape with Pouch

Cat. No.	Nonsterile No.	Qty. Cs
9565	9565N	10

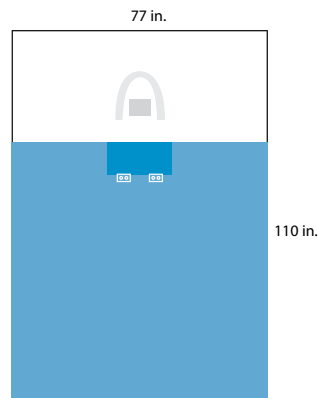

- Attached fluid control pouch with port specifically designed for use with a wrist rest
- Clear view top panel, 77 x 35 in.
- Cord-holding tabs
- Full incise, 5 x 4 in.
- Instrument pad
- SMS material

Eyscape® Ophthalmic Drape with Pouch

Cat. No.	Nonsterile No.	Qty. Cs
9562	9562N	10

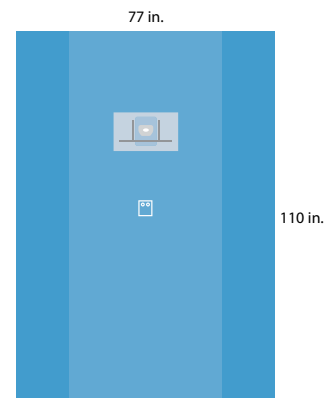

- Attached fluid control saddlebag pouch
- Cord-holding tab
- Malleable breathing bar
- Oval aperture with incise, 1 $\frac{1}{2}$ x 2 $\frac{1}{2}$ in.
- Separate incise sheet, 5 x 4 in.
- SMS material



Eyscape® Small Drape with Adhesive Aperture

Cat. No.	Nonsterile No.	Qty. Cs
8441	8441N	40

- Oval fenestration with full incise, 2 x 3 in.
- SMS material

Astound™ EENT Split Drape

Cat. No.	Nonsterile No.	Qty. Cs
N/A	9442N	

- Absorbent reinforcement, 17 x 20 in.
- Cord-holding tabs
- Instrument pad, 18 x 10 in.
- Split with adhesive, 25 x 2½ in.
- Included in pack 9194

Astound™ EENT Split Drape

Cat. No.	Nonsterile No.	Qty. Cs
N/A	9443N	

- Split with adhesive, 2½ x 25 in.
- Cord-holding tabs
- Instrument pad
- Included in pack 9195

Astound™ Large EENT Split Drape

Cat. No.	Nonsterile No.	Qty. Cs
9447	9447N	8

- Instrument pad
- Split with adhesive, 2½ x 25 in.
- VELCRO® cord-holding tabs
- Included in pack 9196

Tiburon® Large EENT Split Drape

Cat. No.	Nonsterile No.	Qty. Cs
TB9441	9441N	8

- Absorbent, impervious reinforcement, 15¼ x 28 in.
- Cord-holding tabs
- Instrument pad, 15¼ x 9½ in.
- Split with adhesive, 3½ x 28 in.

Astound™ Head/Bar Drape

Cat. No.	Nonsterile No.	Qty. Cs
9556	9556N	20

- Cord-holding tabs
- Turban
- Included in pack 9194

Ophthalmology and EENT

Astound™ Bar Drape

Cat. No. **Nonsterile No.** **Qty. Cs**

N/A 9557N

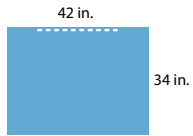

- Adhesive
- Included in pack 9195

Head and Neck Packs

Nonsterile No.	Description	9194 Head and Neck Pack	9195 Head and Neck Pack	9196 Head and Neck Pack	9199 Major Head and Neck Pack
9556N	Tiburon® head/bar drape, adhesive	1		1	1
9441N	Tiburon® large EENT split drape				1
9442N	Tiburon® split drape, reinforced, adhesive	1			
9447N	Astound™ large EENT split drape			1	
9557N	Tiburon® bar drape, adhesive		1		
9443N	Tiburon® split drape, unreinforced, adhesive		1		
90270NA	Astound® standard scrub nurse gown with towel in outer wrap, large	1		1	
89015N	SmartGown™ fully impervious gown, large				1
890015N	SmartGown™ fully impervious gown, with towel in outer wrap, large				1
9515NA	Astound® standard gown, large	1	1	1	
8554N	Drape towel, adhesive, nonabsorbent	2	2	2	1
8520N	Absorbent towel	1		1	1
8337N	Mayo stand cover, reinforced poly, 23 in. wide	1	1	1	1
8694-60	Suture bag	1	1	1	1
8146N	Outer wrap, reinforced poly table cover, 44 x 90 in.	1	1	1	1
	Quantity per case	6	8	6	6

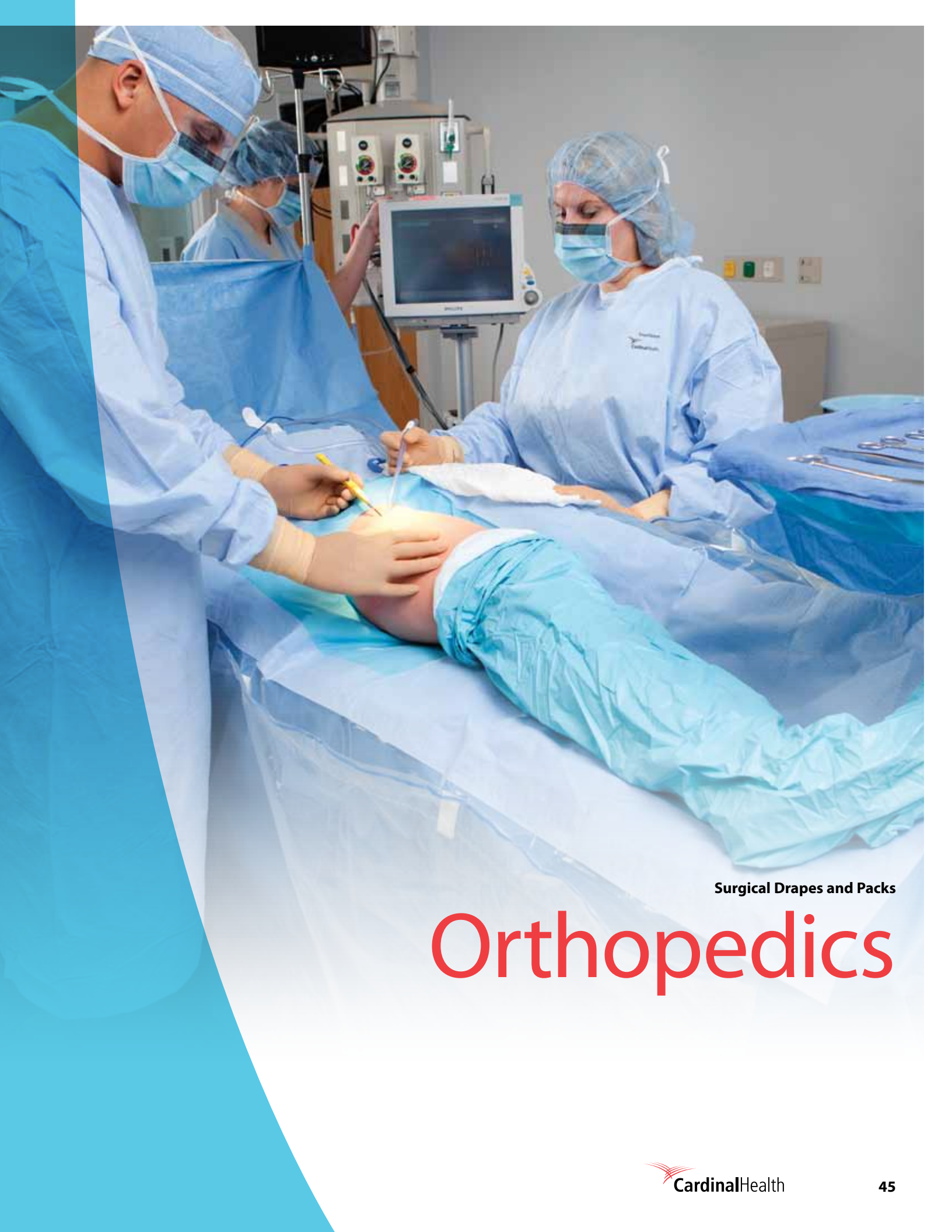

Surgical Drapes and Packs

Orthopedics

Surgical Drapes and Packs

Orthopedics



Orthopedics

Tiburon® HD Extremity Drape

Cat. No.	Nonsterile No.	Qty. Cs
59405	59405N	6

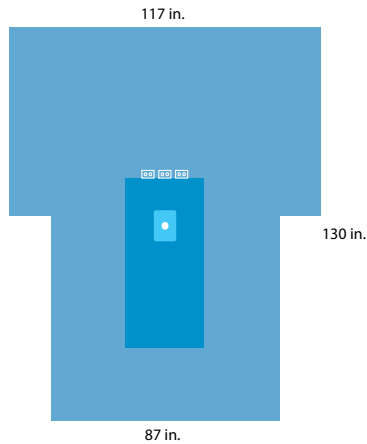

- Absorbent, impervious reinforcement, 30½ x 55½ in.
- Anesthesia screen
- Armboard covers
- Cord-holding tabs
- Fenestration, circular elastic, 2½ in.
- Heavyweight, premium fabric
- Included in pack 59180

Tiburon® HD Arthroscopy Drape

Cat. No.	Nonsterile No.	Qty. Cs
59413	59413N	6

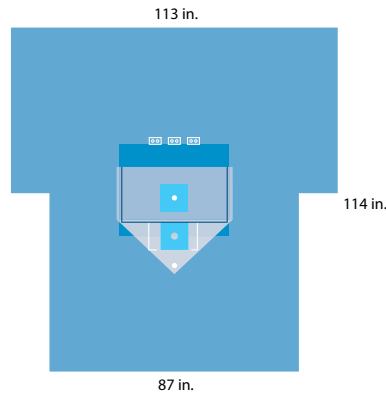

- Absorbent, impervious reinforcement
- Anesthesia screen
- Armboard covers
- Cord-holding tabs
- Dual fenestration, circular elastic, 2 in.
- Fluid control pouch with malleable wire drawstring pouch and port
- Heavyweight, premium fabric
- Included in pack 9197

Tiburon® HD Split Drape

Cat. No.	Nonsterile No.	Qty. Cs
59438	59438N	10

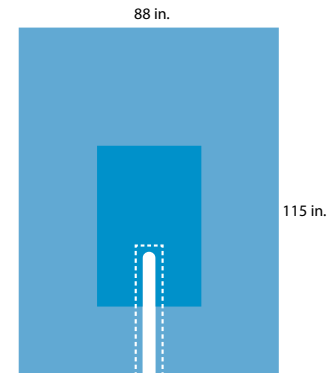

- Absorbent, impervious reinforcement, 33½ x 53 in.
- Heavyweight, premium fabric
- Split with adhesive, 4 x 40 in.

Tiburon® HD Hip Drape with Pouches

Cat. No.	Nonsterile No.	Qty. Cs
59439	59439N	4

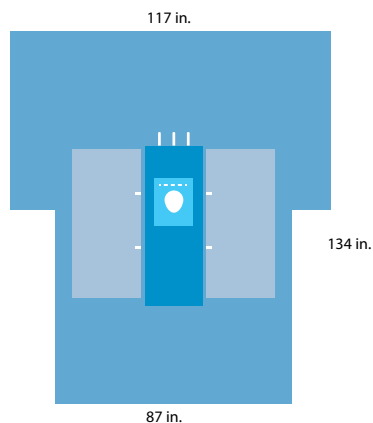

- Absorbent, impervious reinforcement, 21 x 57 in.
- Anesthesia screen
- Armboard covers
- Heavyweight, premium fabric
- Clear leg positioning pouches, 54 x 30 in.
- Fenestration, pear-shaped elastic, 6¾ x 8¾ in.
- VELCRO® cord-holding tabs

Tiburon® HD Top Drape

Cat. No.	Nonsterile No.	Qty. Cs
59352	59352N	10

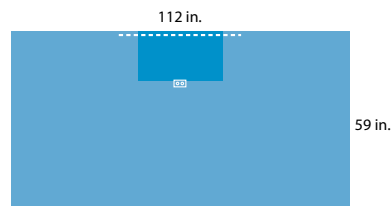

- Absorbent, impervious reinforcement, 28 x 17 in.
- Cord-holding tab
- Heavyweight, premium fabric

Tiburon HD Packs

Nonsterile No.	Description	59180 Tiburon HD Lower Extremity Pack	9197 Tiburon HD Arthroscopy Pack
59405N	Tiburon® HD extremity drape	1	
59413N	Tiburon® HD arthroscopy drape		1
90270NA	Astound® standard scrub nurse gown with towel in outer wrap, large	1	1
32474N	SmartGown™ specialty surgical gown, X-large, X-long	1	1
8520N	Absorbent towel	1	1
8474N	Prep U-drape, 60 x 60 in., 6 x 21 in., split	1	1
8476NA	Prep U-drape, 60 x 72 in., 6 x 21 in., split	1	1
8694-60	Suture bag	1	1
8337N	Mayo stand cover, reinforced poly, 23 in. wide	1	1
1582N	Stockinette, 12 x 48 in., X-large	1	1
FG71-2384C	Tubing, 12 ft. x 6mm	1	1
3524N	Drape tape	3	3
8186N	Outer wrap, reinforced poly table cover, 65 x 90 in., heavy-duty	1	1
	Quantity per case	6	6

Surgical Drapes and Packs

Orthopedics



Orthopedics

Tiburon® Split Drape

Cat. No.	Nonsterile No.	Qty. Cs
29431	29431N	10

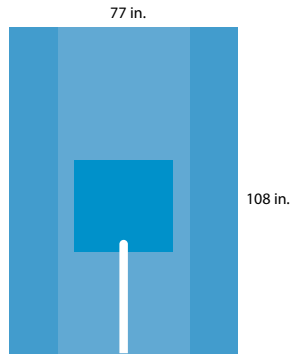

- Absorbent, impervious reinforcement, 34 x 30½ in.
- Split without adhesive, 2½ x 37 in.

Tiburon® Split Drape

Cat. No.	Nonsterile No.	Qty. Cs
29433	29432N	11

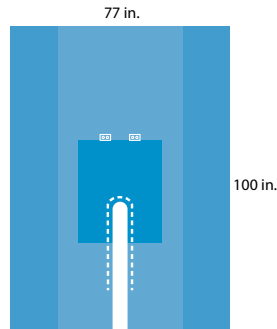

- Absorbent, impervious reinforcement, 30½ x 35 in.
- Cord-holding tabs
- Split with adhesive, 6 x 40 in.

Tiburon® Split Drape

Cat. No.	Nonsterile No.	Qty. Cs
29434	29434N	20

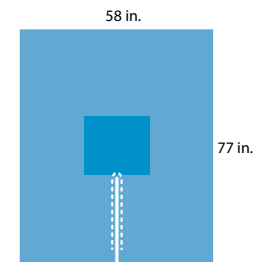

- Absorbent, impervious reinforcement, 20 x 18½ in.
- Split with adhesive, 1 x 28¼ in.

Tiburon® Split Drape

Cat. No.	Nonsterile No.	Qty. Cs
29436	29436N	10

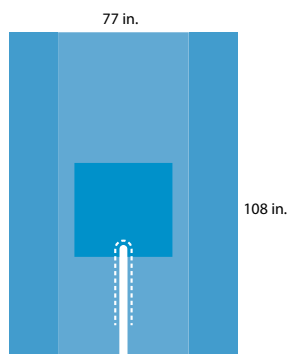

- Absorbent, impervious reinforcement, 34 x 30½ in.
- Split with adhesive, 2½ x 37 in.
- Included in packs 29182, 29183, 29184

Tiburon® Split Drape

Cat. No.	Nonsterile No.	Qty. Cs
29440	29440NA	10

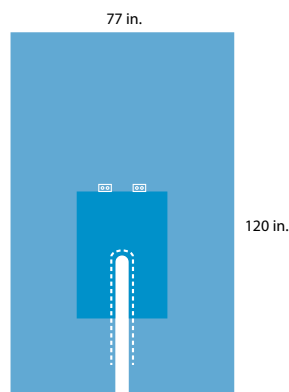

- Absorbent, impervious reinforcement, 30½ x 42 in.
- Cord-holding tabs
- Split with adhesive, 6 x 46 in.

Tiburon® Orthopedic Split Drape

Cat. No.	Nonsterile No.	Qty. Cs
29476	29476N	10

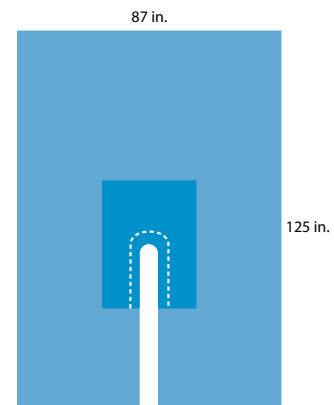

- Absorbent, impervious reinforcement, 30½ x 42 in.
- Split with adhesive, 6 x 54 in.

Tiburon® Split Sheet Drape

Cat. No.	Nonsterile No.	Qty. Cs
29445	29445N	8

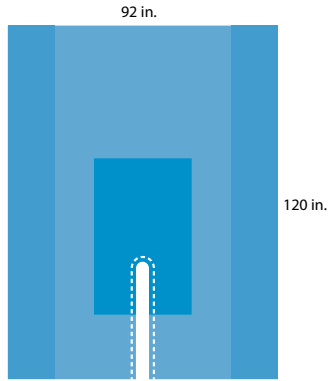

- Absorbent, impervious reinforcement, 33½ x 53 in.
- Split with adhesive, 4 x 40 in.

Tiburon® Split Sheet Drape

Cat. No.	Nonsterile No.	Qty. Cs
29446	29446N	8

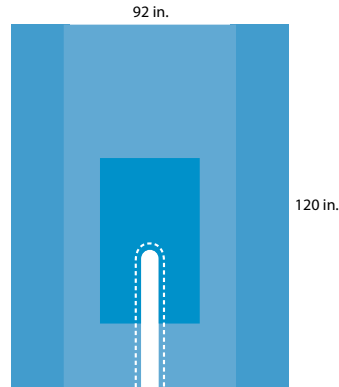

- Absorbent, impervious reinforcement, 33½ x 53 in.
- Split with adhesive, 6 x 46 in.

Tiburon® Split Drape

Cat. No.	Nonsterile No.	Qty. Cs
N/A	9361N	

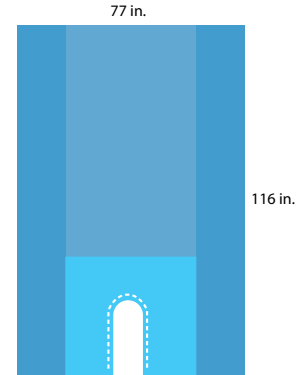

- Impervious reinforcement, 44 x 40 in.
- Split with adhesive, 10 x 25 in.
- Included in packs 9183, 29367, 29365, 29160

General Ortho Packs

Nonsterile No.	Description	29181 General Orthopedic Pack	29182 Orthopedic Pack	29183 Orthopedic Pack
29432N	Tiburon® split drape with absorbent reinforcement, adhesive	1		
29351N	Tiburon® top drape with absorbent reinforcement, adhesive	1		
9349N	Astound™ fan-folded drape sheet, 60 x 76 in.		1	1
29436N	Tiburon® split drape, adhesive		1	1
9040N	Astound® gown, poly reinforced, X-large	2		
8520N	Absorbent towel	2		1
8694-60	Suture bag	1	1	1
8337N	Mayo stand cover, reinforced poly, 23 in. wide	1	1	1
8376N	Plastic sheet, fan-folded, 44 x 75 in.			1
8475N	U-Drape, poly, adhesive, 60 x 84 in., 8 x 30 in. split	1		
8476NA	U-Drape, poly, adhesive, 60 x 72 in., 6 x 21 in. split		1	
1582N	Stockinette, 12 x 48 in., X-large	1		
8554N	Drape towel, adhesive, nonabsorbent	4	4	4
8143N	Outer wrap, reinforced poly table cover, 50 x 90 in.	1	1	1
Quantity per case		4	5	5

Surgical Drapes and Packs

Orthopedics



Orthopedics

Tiburon® Arthroscopy Drape for Dropped and Straight Leg Procedures

Cat. No.	Nonsterile No.	Qty. Cs
9413	9413NA	12

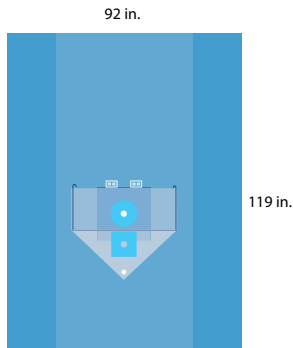

- Absorbent, impervious reinforcement, 20 x 20 in.
- Dual fenestration, circular elastic, 2½ in.
- Fluid control drawstring pouch with port
- Cord-holding tabs
- Included in pack 9187

Tiburon® Arthroscopy Drape for Dropped Leg Procedures

Cat. No.	Nonsterile No.	Qty. Cs
9414	9414NA	12

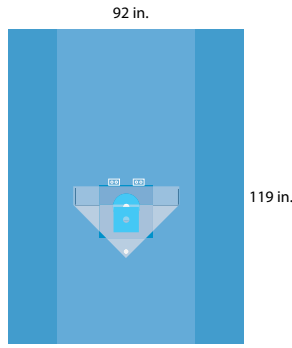

- Absorbent, impervious reinforcement, 20 x 20 in.
- Dual fenestration, circular elastic, 2½ in.
- Fluid control pouch with malleable wire and port
- Cord-holding tabs
- Included in pack 9185

Tiburon® Arthroscopy Drape with Armboard Covers

Cat. No.	Nonsterile No.	Qty. Cs
9423	9423N	12

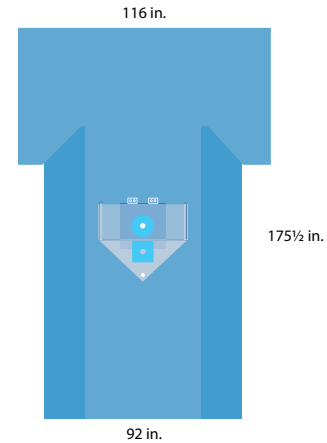

- Absorbent, impervious reinforcement, 20 x 20 in.
- Anesthesia screen
- Armboard covers
- Cord-holding tabs
- Dual fenestration, circular elastic, 2½ in.
- Fluid control pouch with malleable wire and port, 40 x 34 in.

Tiburon® Hip Drape

Cat. No.	Nonsterile No.	Qty. Cs
29430	29430N	12

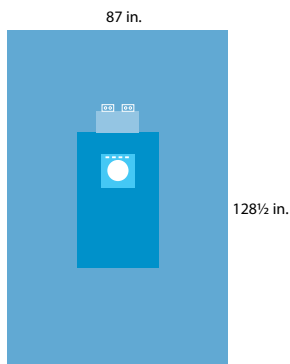

- Absorbent, impervious reinforcement, 30½ x 50 in.
- Cord-holding tabs
- Fenestration, circular elastic, 8 in.
- Instrument pad
- Included in pack 29187

Tiburon® Hip Drape with Pouches

Cat. No.	Nonsterile No.	Qty. Cs
29439	29439N	5

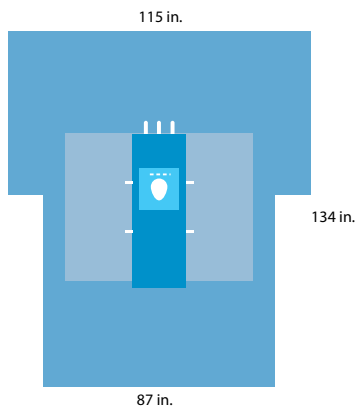

- Absorbent, impervious reinforcement, 21 x 57 in.
- Anesthesia screen
- Armboard covers
- Clear leg positioning pouches, 54 x 30 in.
- Fenestration, pear-shaped elastic, 6¾ x 8¼ in.
- VELCRO® cord-holding tabs

Tiburon® Hip Drape

Cat. No.	Nonsterile No.	Qty. Cs
29444	29444N	5

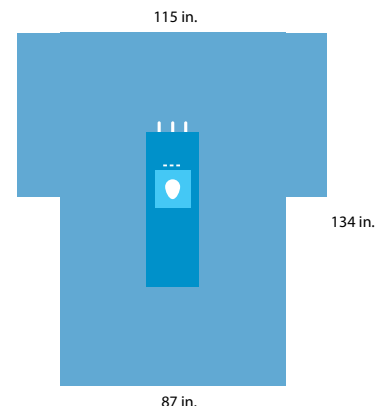





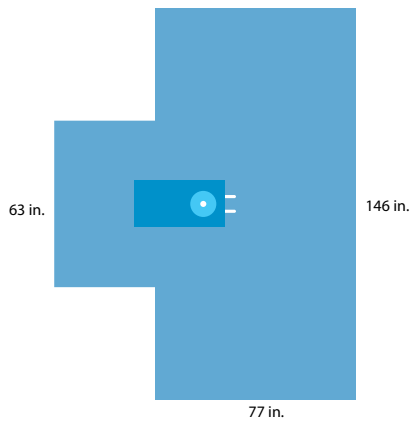

- Absorbent, impervious reinforcement, 21 x 57 in.
- Anesthesia screen
- Armboard covers
- Fenestration, pear-shaped elastic, 6¾ x 8¼ in.
- VELCRO® cord-holding tabs

Tiburon® Hand Drape

Cat. No.	Nonsterile No.	Qty. Cs
29427	29427N	18



- Absorbent, impervious reinforcement, 16¾ x 34 in.
- Fenestration, circular elastic, 2 in.
- Hand table extension
- VELCRO® cord-holding tabs

 Basic drape fabric	 Reinforcements	 Side panel material
 Adhesive	 Incise	 Clear plastic panels, anesthesia screens and pouches

Arthroscopy Hand and Hip Packs

Nonsterile No.	Description	9419 Hand Pack	29187 Hip Pack	9185 Arthroscopy Pack II for Dropped Leg Procedures	9187 Arthroscopy Pack III for Dropped and Straight Leg Procedures
29419N	Tiburon® hand drape	1			
29430N	Tiburon® hip drape		1		
9413NA	Tiburon® arthroscopy drape for dropped and straight leg procedures				1
9414NA	Tiburon® arthroscopy drape with pouch for dropped leg procedures			1	
9040N	Astound® gown, poly reinforced, X-large		2		
32474N	SmartGown™ fully impervious, A-line, X-large, X-long			1	1
90270NA	Astound® standard scrub nurse gown with towel in outer wrap, large			1	1
8520N	Absorbent towel		2		
8694-60	Suture bag	1	1	1	1
8337N	Mayo Stand Cover, reinforced poly, 23 in. wide	1	1	1	1
8475N	U-Drape, poly, adhesive, 60 x 84 in., 8 x 30 in. split		1		
8476NA	Prep U-drape, 60 x 72 in., 6 x 21 in. split	1		2	2
1582N	Stockinette, 12 x 48 in., X-large		1		
1586N	Impervious stockinette, 9 x 48 in., large			1	1
3524	Drape tape			4	4
8554N	Drape towel, adhesive, nonabsorbent		2		
8143N	Outer wrap, reinforced poly table cover, 50 x 90 in.	1	1	1	1
	Quantity per case	5	6	6	6

Tiburon® Extremity Drape

Cat. No.	Nonsterile No.	Qty. Cs
29405	29405N	6

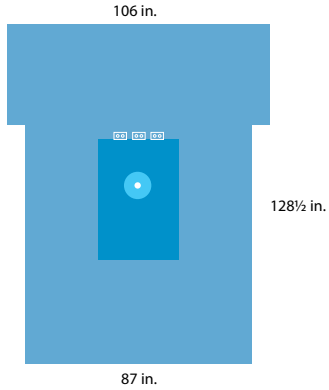

- Absorbent, impervious reinforcement, 30½ x 45 in.
- Anesthesia screen
- Armboard covers
- Cord-holding tabs
- Fenestration, circular elastic, 2½ in.

Tiburon® Extremity Drape

Cat. No.	Nonsterile No.	Qty. Cs
29412	29412N	8

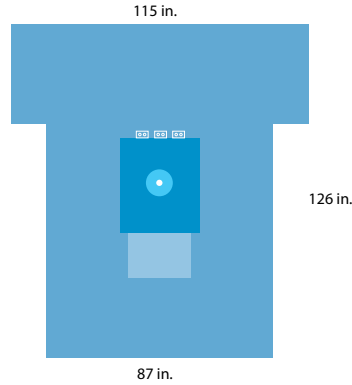

- Absorbent, impervious reinforcement, 30 x 33½ in.
- Anesthesia screen
- Armboard covers
- Cord-holding tabs
- Fenestration, circular elastic, 2½ in.
- Non-slip pad below reinforcement, 27 x 19 in.

Tiburon® Extremity Drape

Cat. No.	Nonsterile No.	Qty. Cs
29413	29413N	12

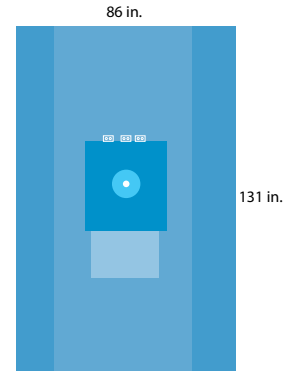

- Absorbent, impervious reinforcement, 30 x 33½ in.
- Cord-holding tabs
- Fenestration, circular elastic, 2½ in.
- Non-slip pad below reinforcement, 27 x 19 in.

Tiburon® Extremity Drape

Cat. No.	Nonsterile No.	Qty. Cs
29414	29414N	12

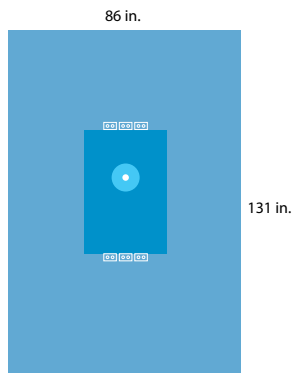

- Absorbent, impervious reinforcement, 30½ x 45 in.
- Cord-holding tabs
- Fenestration, circular elastic, 2½ in.
- Included in packs 29188, 29189

Tiburon® Extremity Drape

Cat. No.	Nonsterile No.	Qty. Cs
29415	29415N	12

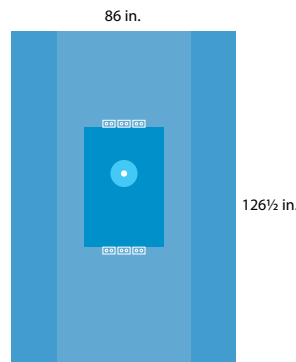

- Absorbent, impervious reinforcement, 30½ x 45 in.
- Cord-holding tabs
- Fenestration, circular elastic, 2½ in.
- Included in packs 29180, 29186

Tiburon® Extremity Drape with Armboard Covers

Cat. No.	Nonsterile No.	Qty. Cs
29435	29435N	8

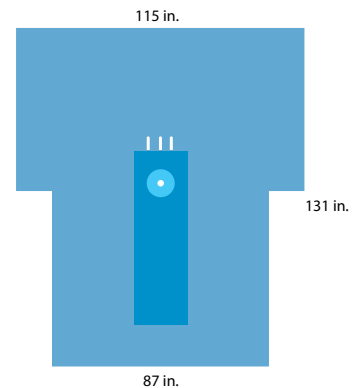

- Absorbent, impervious reinforcement, 24 x 66 in.
- Anesthesia screen
- Armboard covers
- Fenestration, circular elastic, 2½ in.
- VELCRO® cord-holding tabs

Surgical Drapes and Packs

Orthopedics



Orthopedics

Tiburon® Bilateral Limb Drape

Cat. No.	Nonsterile No.	Qty. Cs
29416	29416N	12

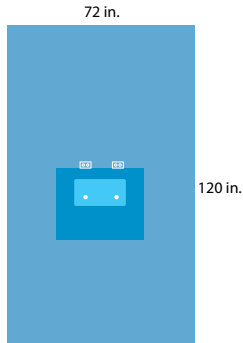

- Absorbent, impervious reinforcement, 33 x 27 in.
- Cord-holding tabs
- Dual fenestration, circular elastic, 1½ in.

Tiburon® Bilateral Limb Drape

Cat. No.	Nonsterile No.	Qty. Cs
29417	29417N	8

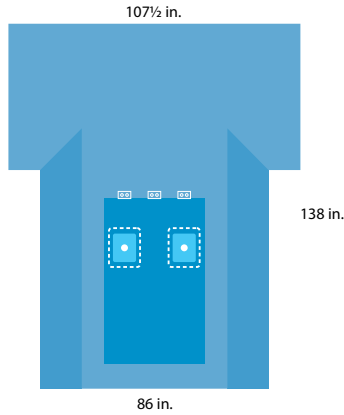

- Absorbent, impervious reinforcement, 37½ x 61 in.
- Anesthesia screen
- Armboard covers
- Cord-holding tabs
- Dual fenestration, circular elastic, 2½ in.

Extremity Packs

Nonsterile No.	Description	29180 Arthroscopy Pack	29186 Arthroscopy Pack	29188 Fluid Control Extremity Pack	29189 Fluid Control Extremity Pack
29415N	Tiburon® extremity drape with absorbent reinforcement	1	1		
29414N	Tiburon® extremity drape			1	1
9040N	Astound® gown, poly reinforced, X-large	1			2
32474N	SmartGown™ gown, fully impervious, A-line, X-large, X-long		1		
90270NA	Astound® standard scrub nurse gown with towel in outer wrap, large		1		
8520N	Absorbent towel	1			1
8694-60	Suture bag	1	1	1	1
8337N	Mayo stand cover, reinforced poly, 23 in. wide	1	1	1	1
8476NA	Prep U-drape, 60 x 72 in., 6 x 21 in. split	1	2		
8375N	Plastic sheet, fan-folded, 44 x 60 in.			1	1
1582N	Stockinette, 12 x 48 in., X-large	1			
1586N	Impervious stockinette, 9 x 48 in., large		1		
3524	Drape tape		4		
8554N	Drape towel, adhesive, nonabsorbent			2	3
8143N	Outer wrap, reinforced poly table cover, 50 x 90 in.	1	1	1	1
	Quantity per case	6	6	5	6

Surgical Drapes and Packs

Orthopedics

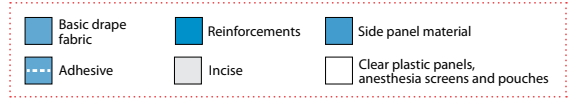

Orthopedics

Tiburon® Beach Chair Shoulder Drape

Cat. No.	Nonsterile No.	Qty. Cs
29369	29369NA	5

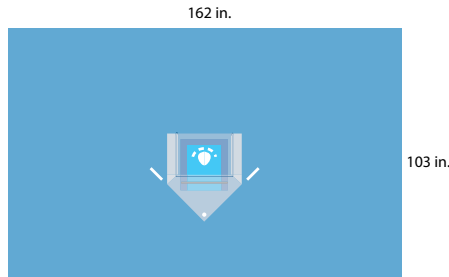

- Fenestration, pear-shaped, 5½ x 5¾ in.
- Fluid control pouch with malleable wire drawstring pouch and port
- VELCRO® cord-holding tabs

Tiburon® Shoulder Drape

Cat. No.	Nonsterile No.	Qty. Cs
N/A	9360N	

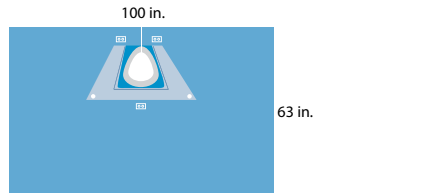

- Fenestration, pear-shaped with split and incise aperture, 11½ x 14 in.
- Fluid control pouch with drawstring and ports
- Cord-holding tabs
- Included in packs 9183, 29367

Tiburon® Split Drape

Cat. No.	Nonsterile No.	Qty. Cs
N/A	9361N	

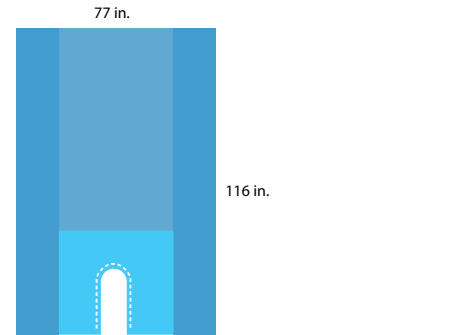

- Impervious reinforcement, 44 x 40 in.
- Split with adhesive, 10 x 25 in.
- Included in packs 9183, 29367, 29365, 29160

Tiburon® Shoulder Drape

Cat. No.	Nonsterile No.	Qty. Cs
N/A	29365N	

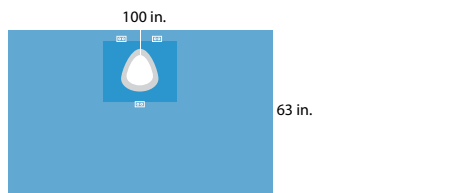

- Absorbent, impervious reinforcement, 31 x 22 in.
- Cord-holding tabs
- Fenestration, pear-shaped with split and incise aperture, 11½ x 14 in.
- Included in packs 29365, 29160

Tiburon® Top Drape

Cat. No.	Nonsterile No.	Qty. Cs
29352	29351N	14

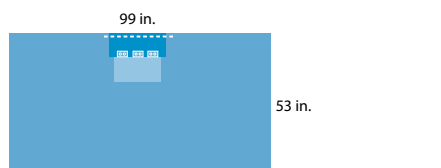

- Absorbent, impervious reinforcement, 20 x 9 in.
- Cord-holding tabs
- Instrument pad
- Included in packs 29181, 29131

Tiburon® Top Drape

Cat. No.	Nonsterile No.	Qty. Cs
N/A	29478N	

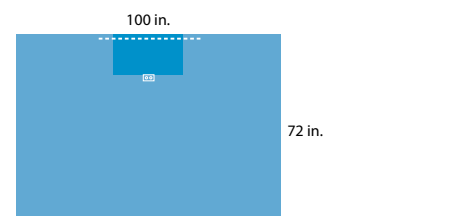

- Absorbent, impervious reinforcement, 26 x 15 in.
- Cord-holding tabs

Shoulder Packs

Nonsterile No.	Description	9183 Fluid Control Shoulder Pack	29367 Fluid Control Shoulder Drape Pack	29365 Shoulder Drape Pack	29160 Shoulder Pack
9360N	Tiburon® shoulder drape with attached fluid control pouch, with incise	1	1		
9361N	Tiburon® split drape, poly reinforced, adhesive	1	1	1	1
29365N	Tiburon® shoulder drape with incise, adhesive			1	1
32474N	SmartGown™ gown, fully impervious, A-line, X-large, X-long	1			1
90270NA	Astound® standard scrub nurse gown with towel in outer wrap, large	1			1
8520N	Absorbent towel				1
8694-60	Suture Bag	1			1
8337N	Mayo Stand Cover, reinforced poly, 23 in. wide	1			1
8476NA	U-Drape, poly, adhesive, 60 x 72 in., 6 x 21 in. split				1
8554N	Drape towel, adhesive, nonabsorbent	4			4
8146N	Outer wrap, reinforced poly table cover, 44 x 90 in.	1			1
	Quantity per case	3	10	8	3



Surgical Drapes and Packs

Pediatrics

Surgical Drapes and Packs

Pediatrics



Pediatrics

Tiburon® Pediatric Drape

Cat. No.	Nonsterile No.	Qty. Cs
29492	29492N	10

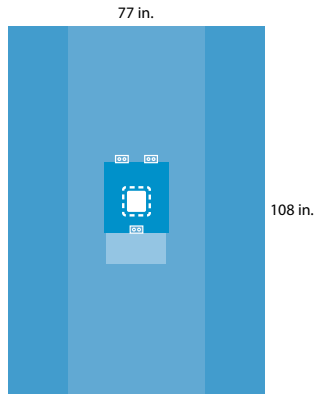

- Absorbent, impervious reinforcement, 19 x 20 in.
- Cord-holding tabs
- Fenestration, 6 x 6 in.
- Instrument pad

Tiburon® Pediatric Drape with Armboard Covers

Cat. No.	Nonsterile No.	Qty. Cs
29493	29493N	10

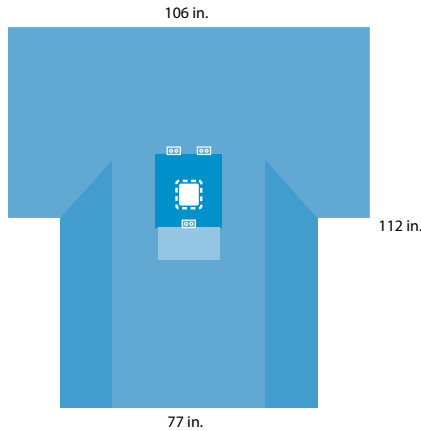

- Absorbent, impervious reinforcement, 19 x 20 in.
- Anesthesia screen
- Armboard covers
- Cord-holding tabs
- Fenestration, 6 x 6 in.
- Instrument pad
- Included in pack 29490

Tiburon® Neonatal Drape

Cat. No.	Nonsterile No.	Qty. Cs
29494	29494N	20

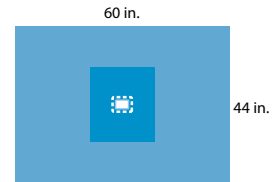

- Absorbent, impervious reinforcement, 20 x 18 in.
- Fenestration, 3 x 4 in.

Neonatal Drape

Cat. No.	Nonsterile No.	Qty. Cs
9133	N/A	15

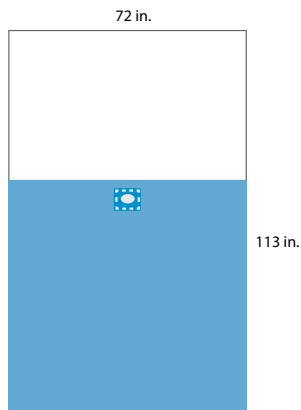

- Absorbent, reinforcement, 10 x 8 in.
- Clear anesthesia screen
- Drapeable blue poly film base material
- Fenestration, oval, 2 x 4 in.

Tiburon® Split Drape

Cat. No.	Nonsterile No.	Qty. Cs
29434	29434N	20

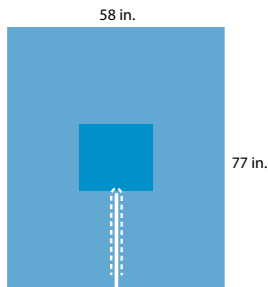

- Absorbent, impervious reinforcement, 20 x 18 in.
- Split with adhesive, 1 x 28 in.

Tiburon® Circumcision Drape

Cat. No.	Nonsterile No.	Qty. Cs
74210	74210N	160

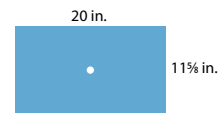

- Fenestration, circular, 5/8 in.

Tiburon® Pediatric Directional Incision Drape

Cat. No.	Nonsterile No.	Qty. Cs
9777	9777N	60



- Fenestration, circular, 4 in.

Pediatric Pack

Nonsterile No.	Description	29490 Pediatric Pack
29493N	Tiburon® pediatric drape	1
9545NA	Astound® standard gown, sterile back, X-large	2
8520N	Absorbent towel	2
8337N	Mayo stand cover, reinforced poly, 23 in. wide	1
8694-60	Suture bag	1
8554N	Drape towel, adhesive, nonabsorbent	4
8146N	Outer wrap, reinforced poly table cover, 44 x 90 in.	1
	Quantity per case	8



Surgical Drapes and Packs

Peri-GYN

Surgical Drapes and Packs
Peri-GYN



Peri-GYN

Astound™ Abdominal Lithotomy Drape

Cat. No.	Nonsterile No.	Qty. Cs
N/A	29300N	

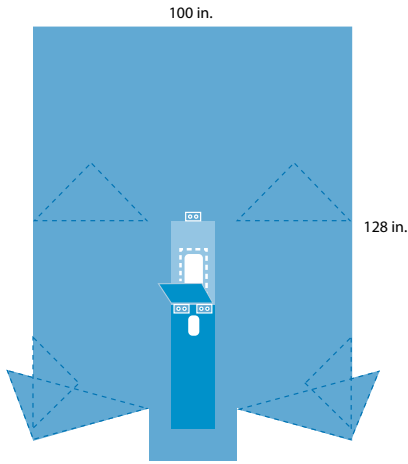

- Absorbent reinforcement, 14 x 26 in.
- Attached leggings
- Cord-holding tabs
- Fenestration, abdominal with adhesive, 6 x 12 in.
- Fenestration, perineal, 3 x 6 in.
- Perineal flap
- Included in pack 29146

Astound™ Laparoscopy Drape

Cat. No.	Nonsterile No.	Qty. Cs
N/A	29402N	

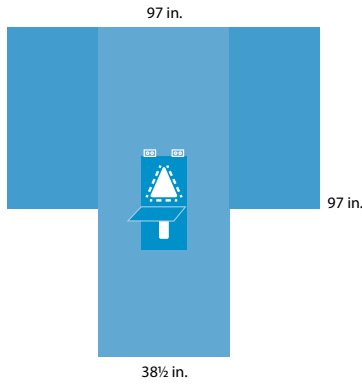

- Absorbent reinforcement, 13 x 27 in.
- Cord-holding tabs
- Fenestration, rectangular, perineal, 3 x 6 in.
- Fenestration, triangular abdominal with adhesive, 8 x 9 in.
- Perineal flap
- Included in pack 29242, 29245

Astound™ Laparoscopy/ Pelviscopy Drape

Cat. No.	Nonsterile No.	Qty. Cs
N/A	29404N	

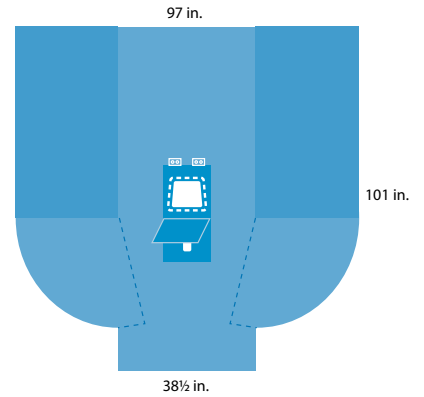

- Absorbent reinforcement, 15 x 27 in.
- Cord-holding tabs
- Fenestration perineal, 3 x 6 in.
- Fenestration, trapezoidal abdominal with adhesive, 7 x 7 x 9 in.
- Perineal flap
- Side gussets for added coverage
- Included in pack 29606, 29604

**Astound™ Laparoscopy/
Pelviscopy Drape**

Cat. No.	Nonsterile No.	Qty. Cs
29407	29407N	10

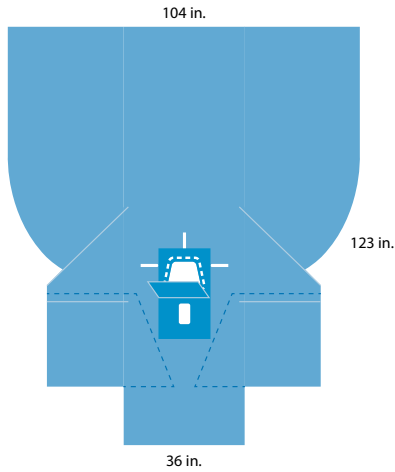

- Absorbent reinforcement, 15 x 26 in.
- Armboard covers
- Fenestration, abdominal with adhesive, 7 x 7 x 7 x 9 in.
- Fenestration, perineal, 3 x 6 in.
- Perineal flap
- VELCRO® cord-holding straps
- Included in pack 29408

Astound™ Laparoscopy Drape

Cat. No.	Nonsterile No.	Qty. Cs
N/A	29403N	

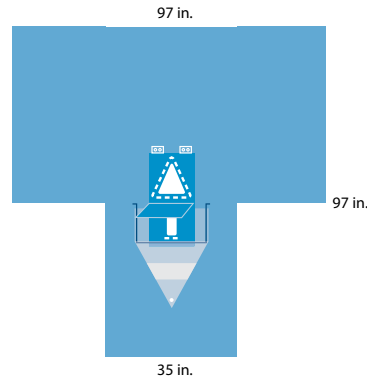

- Absorbent reinforcement, 15 x 27 in.
- Cord-holding tabs
- Fluid control pouch with filtering screen, closed suction port and drawstring
- Rectangular perineal fenestration with adhesive, 3 x 6 in.
- Triangular abdominal fenestration with adhesive, 8 x 9 in.
- Perineal flap
- Included in pack 29503

Astound™ Lithotomy Drape

Cat. No.	Nonsterile No.	Qty. Cs
29455	29455N	8

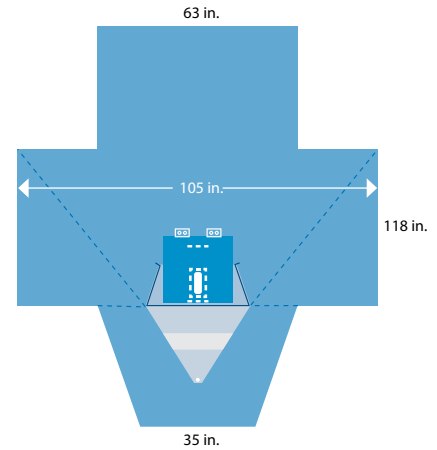

- Absorbent reinforcement, 20 x 19 in.
- Anesthesia screen
- Attached leggings
- Cord-holding tabs
- Fluid control pouch with filtering screen and suction port
- Rectangular perineal fenestration with adhesive, 2½ x 6 in.



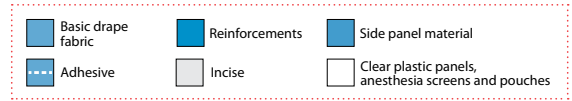

Astound™ Lithotomy “T” Drape

Cat. No.	Nonsterile No.	Qty. Cs
N/A	29438N	

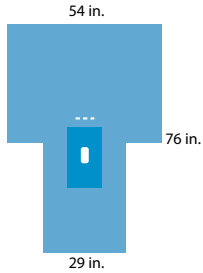

- Absorbent reinforcement, 12 x 20 in.
- Rectangular fenestration, 2½ x 5½ in.
- Included in pack 29276

Astound™ Lithotomy Drape

Cat. No.	Nonsterile No.	Qty. Cs
29450	29450N	10

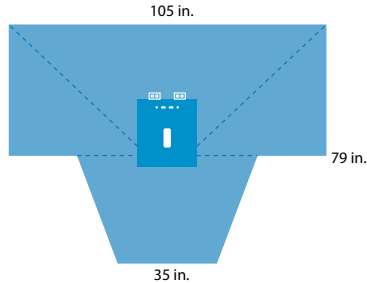

- Absorbent reinforcement, 20 x 22 in.
- Attached leggings
- Cord-holding tabs
- Rectangular fenestration, 2½ x 6½ in.
- Included in pack 29170, 29171

Tiburon® LAVH Drape

Cat. No.	Nonsterile No.	Qty. Cs
29474	29474N	8

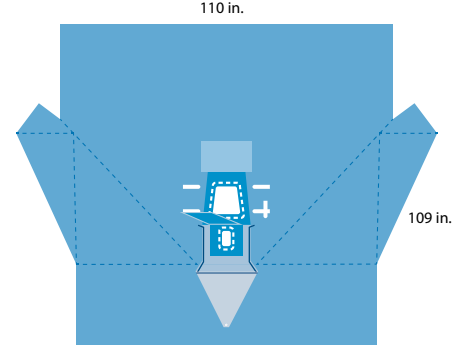

- Absorbent, impervious reinforcement, 12 x 12¾ in.
- Anesthesia screen
- Armboard covers
- Attached leggings with tieback straps
- Fluid control pouch with closed suction port and drawstring
- Instrument pad
- Perineal fenestration with adhesive, 3 x 6 in.
- Perineal flap
- Trapezoidal abdominal fenestration with adhesive, 7 x 9 x 9 in.
- VELCRO® cord-holding tabs
- Included in pack 29475

Peri-GYN Packs

Nonsterile No.	Description	29242 Laparoscopy Pack	29245 Laparoscopy Pack	29606 Laparoscopy/Pelviscopy Pack I	29604 Laparoscopy/Pelviscopy Pack II	29408 Laparoscopy/Pelviscopy Pack III	29503 Fluid Control Laparoscopy Pack	29146 Abdominal Lithotomy Pack	29276 Peri-GYN Pack	29170 Peri-GYN Pack	29171 Peri-GYN Pack	29475 LAVH/Laparoscopy Pack	9165 Peri-GYN Pack	9274 Peri-GYN Pack
29438N	Tiburon® lithotomy "T" drape with absorbent reinforcement, adhesive								1					
29450N	Tiburon® lithotomy drape with absorbent reinforcement, attached leggings									1	1			
29474N	Tiburon® LAVH drape											1		
29402N	Tiburon® laparoscopy drape with absorbent reinforcement, adhesive	1	1											
29404N	Tiburon® laparoscopy/pelviscopy drape with gussets, absorbent reinforcement, adhesive			1	1									
29407N	Astound™ laparotomy/pelviscopy drape					1								
29403N	Tiburon® laparoscopy drape						1							
29300N	Astound® abdominal lithotomy drape							1						
9359N	Drape sheet, adhesive												1	1
8483N	Under-buttocks drape, reinforced poly		1	1	1	1		1		1	1	1	1	1
90680NA	Astound® impervious reinforced gown with towel in outer wrap, large											1		
9040N	Astound® gown, poly reinforced, X-large											2		
90270NA	Astound® standard scrub nurse gown with towel in outer wrap, large		1											
9515NA	Astound® standard gown, sterile back, large		1								1			1
8554N	Drape towel, adhesive, nonabsorbent	1	1		2	2			1	1	1		1	1
8520N	Absorbent towel	1	1						1	1	1		1	1
8421N	Pair of leggings, X-large	1	1	1	1	1	1		1				1	1
8694-60	Suture bag	1	1		1	1			1	1	1	1	1	1
8337N	Mayo Stand Cover, reinforced poly, 23 in. wide		1		1	1						1		
8146N	Outer wrap, reinforced poly table cover, 44 x 90 in.	1	1		1	1			1				1	1
8149N	Outer wrap, reinforced poly table cover, 44 x 85 in., reinforcement 24 x 85 in.									1	1			
8143N	Outer wrap, reinforced poly table cover, 50 x 90 in.												1	
	Quantity per case	10	8	10	10	10	10	8	10	12	5	4	12	10

Peri-GYN



Surgical Drapes and Packs

Standard Packs

Standard Packs

Setup Packs

Setup Pack

Cat. No. 114

NS Cat. No.	Contents	Qty. Cs
8694-60	1 Suture bag	12
8337N	1 Mayo stand cover, reinforced poly, 23 in. wide	
8146N	1 Outer wrap, reinforced poly table cover, 44 x 90 in.	

Setup Pack

Cat. No. 117

NS Cat. No.	Contents	Qty. Cs
8694-60	1 Suture bag	13
8337N	1 Mayo stand cover, reinforced poly, 23 in. wide	
8554N	4 Drape towel, adhesive, nonabsorbent	
8143N	1 Outer wrap, reinforced poly table cover, 50 x 90 in.	

Setup Pack

Cat. No. 9102

NS Cat. No.	Contents	Qty. Cs
8694-60	1 Suture bag	12
8337N	1 Mayo stand cover, reinforced poly, 23 in. wide	
8186N	1 Outer wrap, reinforced poly table cover, 65 x 90 in., heavy-duty	

General Surgery

Basic Packs

Basic Pack

Cat. No. 9100

NS Cat. No.	Contents	Qty. Cs
8694-60	1 Suture bag	12
8337N	1 Mayo stand cover, reinforced poly, 23 in. wide	
8554N	4 Drape towel, adhesive, nonabsorbent	
9358N	1 Astound™ fan-folded drape sheet, 44 x 57 in.	
9349N	1 Astound™ fan-folded drape sheet, 60 x 76 in.	
8146N	1 Outer wrap, reinforced poly table cover, 44 x 90 in.	

Basic Pack

Cat. No. 9101

NS Cat. No.	Contents	Qty. Cs
8694-60	1 Suture bag	5
8337N	1 Mayo stand cover, reinforced poly, 23 in. wide	
90270NA	1 Astound® standard scrub nurse gown, large, with towel in outer wrap	
9515NA	1 Astound® standard gown, sterile back, large	
8146N	1 Outer wrap, reinforced poly table cover, 44 x 90 in.	

Basic Pack

Cat. No. 9103

NS Cat. No.	Contents	Qty. Cs
8694-60	1 Suture bag	8
8337N	1 Mayo stand cover, reinforced poly, 23 in. wide	
8554N	4 Drape towel, adhesive, nonabsorbent	
9358N	1 Astound™ fan-folded drape sheet, 44 x 57 in.	
9349N	1 Astound™ fan-folded drape sheet, 60 x 76 in.	
90270NA	1 Astound® standard scrub nurse gown, large, with towel in outer wrap	
9515NA	1 Astound® standard gown, sterile back, large	
8146N	1 Outer wrap, reinforced poly table cover, 44 x 90 in.	

Basic Pack

Cat. No. 9109

NS Cat. No.	Contents	Qty. Cs
8694-60	1 Suture bag	10
8337N	1 Mayo stand cover, reinforced poly, 23 in. wide	
9349N	1 Astound™ fan-folded drape sheet, 60 x 76 in.	
8143N	1 Outer wrap, reinforced poly table cover, 50 x 90 in.	

Basic Pack

Cat. No. 9111

NS Cat. No.	Contents	Qty. Cs
8694-60	1 Suture bag	5
8337N	1 Mayo stand cover, reinforced poly, 23 in. wide	
8554N	4 Drape towel, adhesive, nonabsorbent	
9349N	1 Astound™ fan-folded drape sheet, 60 x 76 in.	
90970N	1 Astound® scrub nurse reinforced gown, large, with towel in outer wrap	
9511N	1 Astound® gown, sterile back, fabric reinforced, large	
8146N	1 Outer wrap, reinforced poly table cover, 44 x 90 in.	
8520N	1 Absorbent towel	

Basic Pack

Cat. No. 9112

NS Cat. No.	Contents	Qty. Cs
8694-60	1 Suture bag	10
8337N	1 Mayo stand cover, reinforced poly, 23 in. wide	
8554N	4 Drape towel, adhesive, nonabsorbent	
9349N	1 Astound™ fan-folded drape sheet, 60 x 76 in.	
8146N	1 Outer wrap, reinforced poly table cover, 44 x 90 in.	

Standard Packs

Basic Pack**Cat. No. 9113**

NS Cat. No.	Contents	Qty. Cs 5
8694-60	1 Suture bag	
8337N	1 Mayo stand cover, reinforced poly, 23 in. wide	
8554N	4 Drape towel, adhesive, nonabsorbent	
9349N	1 Astound™ fan-folded drape sheet, 60 x 76 in.	
90270NA	1 Astound® standard scrub nurse gown, large, with towel in outer wrap	
9515NA	1 Astound® standard gown, sterile back, large	
8146N	1 Outer wrap, reinforced poly table cover, 44 x 90 in.	
8520N	1 Absorbent towel	

Basic Pack**Cat. No. 9114**

NS Cat. No.	Contents	Qty. Cs 5
8520N	1 Absorbent towel	
8694-60	1 Suture bag	
8337N	1 Mayo stand cover, reinforced poly, 23 in. wide	
8554N	4 Drape towel, adhesive, nonabsorbent	
9349N	1 Astound™ fan-folded drape sheet, 60 x 76 in.	
8143N	1 Outer wrap/reinforced poly table cover, 50 x 90 in.	
9010N	1 Astound® gown, impervious, reinforced, large	
90680NA	1 Astound® gown, impervious, reinforced, large, with towel in outer wrap	

Basic Pack**Cat. No. 9131**

NS Cat. No.	Contents	Qty. Cs 7
8694-60	1 Suture bag	
8337N	1 Mayo stand cover, reinforced poly, 23 in. wide	
90270NA	1 Astound® standard scrub nurse gown, large, with towel in outer wrap	
9515NA	1 Astound® standard gown, sterile back, large	
8186N	1 Outer wrap, reinforced poly table cover, 65 x 90 in., heavy-duty	

Universal Packs

Universal Pack

Cat. No. 9106

NS Cat. No.	Contents	Qty. Cs
9465N	2 Tiburon® side drape, adhesive	5
9468N	1 Tiburon® foot drape, adhesive	
9467N	1 Tiburon® head drape, adhesive	
8520N	1 Absorbent towel	
8337N	1 Mayo stand cover, reinforced poly, 23 in. wide	
8694-60	1 Suture bag	
8146N	1 Outer wrap, reinforced poly table cover, 44 x 90 in.	

Universal Pack

Cat. No. 29107

NS Cat. No.	Contents	Qty. Cs
29465NA	2 Tiburon® side drape with tape	6
29469N	1 Tiburon® foot drape	
29467N	1 Tiburon® head drape with reinforcement	
90270NA	1 Astound® standard scrub nurse gown, large, with towel in outer wrap	
9515NA	1 Astound® standard gown, sterile back, large	
8520N	1 Absorbent towel	
8554N	4 Drape towel, adhesive, nonabsorbent	
8337N	1 Mayo stand cover, reinforced poly, 23 in wide	
8694-60	1 Suture bag	
8146N	1 Outer wrap, reinforced poly table cover, 44 x 90 in.	

Universal Pack

Cat. No. 29118

NS Cat. No.	Contents	Qty. Cs
29669N	1 Tiburon® foot drape with adhesive, 77 x 75 in.	6
29667N	1 Tiburon® head drape with adhesive, 72 x 112 in.	
29665N	2 Tiburon® side drape with tape, 44 x 77 in.	
8554N	4 Drape towel, adhesive, nonabsorbent	
8337N	1 Mayo stand cover, reinforced poly, 23 in. wide	
8694-60	1 Suture bag	
8146N	1 Outer wrap, reinforced poly table cover, 44 x 90 in.	
8520N	1 Absorbent towel	

Standard Packs

Universal Split Pack

Cat. No. 29131

NS Cat. No.	Contents	Qty. Cs
29440NA	1 Tiburon® split drape with absorbent reinforcement	4
29351N	1 Tiburon® top drape, absorbent reinforcement/ instrument pad 53 x 99 in.	
8554N	4 Drape towel, adhesive, nonabsorbent	
8337N	1 Mayo stand cover, reinforced poly, 23 in. wide	
8694-60	1 Suture bag	
8143N	1 Outer wrap/reinforced poly table cover, 50 x 90 in.	

Universal Split Pack II

Cat. No. 29133

NS Cat. No.	Contents	Qty. Cs
29194N	1 Tiburon® chest/breast U-drape with 29 x 39 in. absorbent reinforcement, 12 x 30½ in., split	10
29195N	1 Tiburon® bar sheet with armboard covers	
8554N	4 Drape towel, adhesive, nonabsorbent	
8337N	1 Mayo stand cover, reinforced poly, 23 in. wide	
8694-60	1 Suture bag	
8143N	1 Outer wrap/reinforced poly table cover, 50 x 90 in.	

Laparotomy Packs

Laparotomy Pack

Cat. No. 29127

NS Cat. No.	Contents	Qty. Cs
9358N	2 Astound™ fan-folded drape sheet, 44 x 57 in.	6
29410N	1 Tiburon® laparotomy drape with absorbent reinforcement and armboard covers	
9511N	2 Astound® fabric reinforced gown, large	
8554N	4 Drape towel, adhesive, nonabsorbent	
8520N	3 Absorbent towel	
8337N	1 Mayo stand cover, reinforced poly, 23 in. wide	
8694-60	1 Suture bag	
8146N	1 Outer wrap, reinforced poly table cover, 44 x 90 in.	

Laparotomy Pack

Cat. No. 29130

NS Cat. No.	Contents	Qty. Cs
29410N	1 Tiburon® laparotomy drape with absorbent reinforcement and armboard covers	4
90680NA	1 Astound® gown, impervious, reinforced, large, with towel in outer wrap	
9010N	1 Astound® gown, impervious, reinforced, large	
8554N	4 Drape towel, adhesive, nonabsorbent	
8520N	1 Absorbent towel	
8337N	1 Mayo stand cover, reinforced poly, 23 in. wide	
8694-60	1 Suture bag	
8143N	1 Outer wrap, reinforced poly table cover, 50 x 90 in.	

Laparotomy Pack

Cat. No. 29136

NS Cat. No.	Contents	Qty. Cs
9358N	1 Astound™ fan-folded drape sheet, 44 x 57 in.	5
29410N	1 Tiburon® laparotomy drape with absorbent reinforcement and armboard covers	
8554N	4 Drape towel, adhesive, nonabsorbent	
8520N	1 Absorbent towel	
8337N	1 Mayo stand cover, reinforced poly, 23 in. wide	
8694-60	1 Suture bag	
8143N	1 Outer wrap, reinforced poly table cover, 50 x 90 in.	

Laparotomy Pack

Cat. No. 29137

NS Cat. No.	Contents	Qty. Cs
29410N	1 Tiburon® laparotomy drape with absorbent reinforcement and armboard covers	6
9511N	2 Astound® fabric reinforced gown, large	
8554N	4 Drape towel, adhesive, nonabsorbent	
8520N	2 Absorbent towel	
8337N	1 Mayo stand cover, reinforced poly, 23 in. wide	
8694-60	1 Suture bag	
8146N	1 Outer wrap, reinforced poly table cover, 44 x 90 in.	

Laparotomy Pack

Cat. No. 29138

NS Cat. No.	Contents	Qty. Cs
29410N	1 Tiburon® laparotomy drape with absorbent reinforcement and armboard covers	10
8554N	4 Drape towel, adhesive, nonabsorbent	
8520N	1 Absorbent towel	
8337N	1 Mayo stand cover, reinforced poly, 23 in. wide	
8694-60	1 Suture bag	
8146N	1 Outer wrap, reinforced poly table cover, 44 x 90 in.	

Standard Packs

Laparotomy Pack

Cat. No. 29140

NS Cat. No.	Contents	Qty. Cs
29410N	1 Tiburon® laparotomy drape with absorbent reinforcement and armboard covers	4
9515NA	1 Astound® standard gown, sterile back, large	
8554N	4 Drape towel, adhesive, nonabsorbent	
90270NA	1 Astound® standard scrub nurse gown, large, with towel in outer wrap	
8337N	1 Mayo stand cover, reinforced poly, 23 in. wide	
8694-60	1 Suture bag	
8146N	1 Outer wrap, reinforced poly table cover, 44 x 90 in.	

Laparotomy Pack

Cat. No. 29120

NS Cat. No.	Contents	Qty. Cs
9358N	2 Astound™ fan-folded drape sheet, 44 x 57 in.	5
29411N	1 Tiburon® laparotomy drape, absorbent reinforcement	
8554N	4 Drape towel, adhesive, nonabsorbent	
8520N	1 Absorbent towel	
8337N	1 Mayo stand cover, reinforced poly, 23 in. wide	
8694-60	1 Suture bag	
8146N	1 Outer wrap, reinforced poly table cover, 44 x 90 in.	

Transverse Laparotomy Pack

Cat. No. 29121

NS Cat. No.	Contents	Qty. Cs
29421N	1 Transverse laparotomy drape, absorbent reinforcement	6
9515NA	1 Astound® standard gown, sterile back, large	
90270NA	1 Astound® standard scrub nurse gown, large, with towel in outer wrap	
8554N	4 Drape towel, adhesive, nonabsorbent	
8520N	1 Absorbent towel	
8337N	1 Mayo stand cover, reinforced poly, 23 in. wide	
8694-60	1 Suture bag	
8146N	1 Outer wrap, reinforced poly table cover, 44 x 90 in.	

Laparotomy Pack

Cat. No. 9135

NS Cat. No.	Contents	Qty. Cs
9412N	1 Tiburon® laparotomy drape	10
8554N	4 Drape towel, adhesive, nonabsorbent	
8520N	1 Absorbent towel	
8337N	1 Mayo stand cover, reinforced poly, 23 in. wide	
8694-60	1 Suture bag	
8146N	1 Outer wrap, reinforced poly table cover, 44 x 90 in.	

Laparotomy Pack

Cat. No. 9139

NS Cat. No.	Contents	Qty. Cs
9412N	1 Tiburon® laparotomy drape	6
9515NA	2 Astound® standard gown, sterile back	
8554N	4 Drape towel, adhesive, nonabsorbent	
8520N	2 Absorbent towel	
8337N	1 Mayo stand cover, reinforced poly, 23 in. wide	
8694-60	1 Suture bag	
8146N	1 Outer wrap, reinforced poly table cover, 44 x 90 in.	

General Endoscopy Pack

Cat. No. 9120

NS Cat. No.	Contents	Qty. Cs
9458N	1 Tiburon® general endoscopy drape	6
90270NA	1 Astound® standard scrub nurse gown, large, with towel in outer wrap	
9515NA	1 Astound® standard gown, sterile back, large	
8554N	4 Drape towel, adhesive, nonabsorbent	
7148N	10 x-ray detectable sponge, 4 x 4 in.	
8337N	1 Mayo stand cover, reinforced poly, 23 in. wide	
8694-60	1 Suture bag	
8146N	1 Outer wrap, reinforced poly table cover, 44 x 90 in.	

Cardiovascular

Cardiovascular Packs

CV Pack

Cat. No. 9150

NS Cat. No.	Contents	Qty. Cs
8694-60	1 Suture bag	4
8520N	2 Absorbent towel	
8337N	1 Mayo stand cover, reinforced poly, 23 in. wide	
9541N	3 Astound® gown, sterile back, fabric reinforced, X-large	
8554N	6 Drape towel, adhesive, nonabsorbent	
9150N	1 CV drape, non-fenestrated	
9349N	1 Astound™ fan-folded drape sheet, 60 x 76 in.	
8143N	1 Outer wrap, reinforced poly table cover, 50 x 90 in.	

Standard Packs

CV Pack with Impervious Reinforced Gowns**Cat. No. 29153**

NS Cat. No.	Contents	Qty. Cs 3
8694-60	1 Suture bag	
8554N	6 Drape towel, adhesive, nonabsorbent	
8520N	1 Absorbent towel	
9040N	2 Astound® impervious reinforced gown, X-large	
90780N	1 Astound® impervious reinforced scrub nurse gown, X-large, with towel in outer wrap	
8188N	1 Overhead table cover with sterile extension	
8470N	1 Plastic sheet	
29464N	1 Bottom drape with reinforcement	
29462N	2 Side drapes with tape	
29467N	1 Head drape with reinforcement (on bottom)	
29468N	1 Foot drape with reinforcement (on top)	
9460N	1 Peri-towel	
8143N	1 Outer wrap, reinforced poly table cover, 50 x 90 in.	

CV Split Pack II**Cat. No. 29158**

NS Cat. No.	Contents	Qty. Cs 3
8694-60	1 Suture bag	
8337N	1 Mayo stand cover, reinforced poly, 23 in. wide	
9040N	2 Astound® impervious reinforced gown, X-large	
90680NA	1 Astound® impervious reinforced scrub nurse gown, large with towel in outer wrap	
7554N	8 Drape towel with adhesive strip, 19 x 30 in.	
9158N	1 CV split drape II	
9154N	1 Cardiovascular Peri-Groin drape, 82 x 75 in.	
9349N	1 Astound™ fan-folded drape sheet, 60 x 76 in.	
8152N	1 Outer wrap/table cover, heavy-duty absorbent, 80 x 110 in.	

Cystoscopy

Cystoscopy Packs

Cystoscopy Pack Cat. No. 29470

NS Cat. No.	Contents	Qty. Cs
8694-60	1 Suture bag	10
8520N	1 Absorbent towel	
9515NA	1 Astound® standard gown, sterile back, large	
8421N	1 Pair of leggings, X-large	
29437NA	1 Cystoscopy T-drape	
8145N	1 Outer wrap, reinforced poly table cover, 44 x 75 in.	

Cystoscopy Pack Cat. No. 29471

NS Cat. No.	Contents	Qty. Cs
8694-60	1 Suture bag	8
8520N	1 Absorbent towel	
32474N	1 SmartGown™ fully impervious X-large, X-long	
8421N	1 Pair of leggings, X-large	
29437NA	1 Cystoscopy T-drape	
8145N	1 Outer wrap, reinforced poly table cover, 44 x 75 in.	

Cystoscopy Pack Cat. No. 29480

NS Cat. No.	Contents	Qty. Cs
8694-60	1 Suture bag	14
8520N	1 Absorbent towel	
8421N	1 Pair of leggings, X-large	
29437NA	1 Cystoscopy T-drape	
8145N	1 Outer wrap, reinforced poly table cover, 44 x 75 in.	

Cystoscopy Pack Cat. No. 29360

NS Cat. No.	Contents	Qty. Cs
8694-60	1 Suture bag	10
8520N	1 Absorbent towel	
29451N	1 Astound™ urological drape	
8145N	1 Outer wrap, reinforced poly table cover, 44 x 75 in.	

Cystoscopy Pack Cat. No. 9520E

NS Cat. No.	Contents	Qty. Cs
8694-60	1 Suture bag	10
8421N	1 Pair of leggings, X-large	
9461N	2 Astound™ drape sheet, square-folded, 38½ x 39½ in.	
8145N	1 Outer wrap, reinforced poly table cover, 44 x 75 in.	

Standard Packs

Obstetrics

Obstetrical Pack

Obstetrical Pack

Cat. No. 29920

NS Cat. No.	Contents	Qty. Cs
29357N	1 Astound™ abdominal cover with absorbent reinforcement	6
8421N	1 Pair of leggings, X-large	
8483N	1 Under-buttocks drape, reinforced poly	
8365N	1 Setup cover, 44 x 71 in.	
8520N	2 Absorbent towel	
8145N	1 Outer wrap/reinforced poly table cover, 44 x 75 in., reinforcement 24 x 75 in.	

Ophthalmology

Head and Neck Packs

Head and Neck Pack

Cat. No. 9194

NS Cat. No.	Contents	Qty. Cs
9556N	1 Tiburon® head/bar drape, adhesive	6
9442N	1 Tiburon® split sheet drape, reinforced, adhesive	
90270NA	1 Astound® standard scrub nurse gown, large with towel in outer wrap	
9515NA	1 Astound® standard gown, sterile back, large	
8554N	2 Drape towel, adhesive, nonabsorbent	
8520N	1 Absorbent towel	
8337N	1 Mayo stand cover, reinforced poly, 23 in. wide	
8694-60	1 Suture bag	
8146N	1 Outer wrap, reinforced poly table cover, 44 x 90 in.	

Head and Neck Pack

Cat. No. 9195

NS Cat. No.	Contents	Qty. Cs
9557N	1 Tiburon® bar drape, adhesive	8
9443N	1 Tiburon® split sheet, unreinforced, adhesive	
9515NA	1 Astound® standard gown, sterile back	
8554N	2 Drape towel, adhesive, nonabsorbent	
8337N	1 Mayo stand cover, reinforced poly, 23 in. wide	
8694-60	1 Suture bag	
8146N	1 Outer wrap, reinforced poly table cover, 44 x 90 in.	

Head and Neck Pack

Cat. No. 9196

NS Cat. No.	Contents	Qty. Cs
9556N	1 Tiburon® head/bar drape, adhesive	6
9447N	1 Tiburon® large EENT split drape	
90270NA	1 Astound® standard scrub nurse gown, large, with towel in outer wrap	
9515NA	1 Astound® standard gown, sterile back, large	
8520N	1 Absorbent towel	
8337N	1 Mayo stand cover, reinforced poly, 23 in. wide	
8694-60	1 Suture bag	
8554N	2 Drape towel, adhesive, non-absorbant	
8146N	1 Outer wrap, reinforced poly table cover, 44 x 90 in.	

Major Head and Neck Pack

Cat. No. 9199

NS Cat. No.	Contents	Qty. Cs
9556N	1 Tiburon® head/bar drape, adhesive	6
9441N	1 Tiburon® large reinforced EENT split drape	
890015N	1 SmartGown™ scrub nurse gown, large with towel and wrap	
89015N	1 SmartGown™ surgical gown, large	
8520N	1 Absorbent towel	
8337N	1 Mayo stand cover, reinforced poly, 23 in. wide	
8694-60	1 Suture bag	
8554N	2 Drape towel, adhesive, non-absorbant	
8146N	1 Outer wrap, reinforced poly table cover, 44 x 90 in.	

Orthopedic

Tiburon® HD Lower Extremity Packs

Tiburon® HD Lower Extremity Pack

Cat. No. 59180

NS Cat. No.	Contents	Qty. Cs
59405N	1 Tiburon® HD extremity drape	6
90270NA	1 Astound® standard scrub nurse gown, large, with towel in outer wrap	
32474N	1 SmartGown™ fully impervious X-large, X-long	
8520N	1 Absorbent towel	
8474N	1 Prep U-drape, 60 x 60 in.	
8476NA	1 Prep U-drape, 60 x 72 in.	
8694-60	1 Suture bag	
8337N	1 Mayo stand cover, reinforced poly, 23 in. wide	
1582N	1 Stockinette, 12 x 48 in., X-large	
FG71-2384C	1 Tubing, 6mm x 12'	
3524	3 Drape tape	
8186N	1 Outer wrap, reinforced poly table cover, 65 x 90 in., heavy-duty	

Standard Packs

Tiburon® HD Arthroscopy Pack**Cat. No. 9197**

NS Cat. No.	Contents	Qty. Cs
59413N	1 Tiburon® HD arthroscopy drape	6
90270NA	1 Astound® standard scrub nurse gown, large, with towel in outer wrap	
32474N	1 SmartGown™ fully impervious X-large, X-long	
8520N	1 Absorbent towel	
8474N	1 Prep U-drape, 60 x 60 in.	
8476NA	1 Prep U-drape, 60 x 72 in.	
8694-60	1 Suture bag	
8337N	1 Mayo stand cover, reinforced poly, 23 in. wide	
1582N	1 Stockinette, 12 x 48 in., X-large	
FG71-2384C	1 Tubing, 12' x 6mm	
3524	3 Drape tape	
8186N	1 Outer wrap, reinforced poly table cover, 65 x 90 in., heavy-duty	

Orthopedic Packs**General Orthopedic Pack****Cat. No. 29181**

NS Cat. No.	Contents	Qty. Cs
29432N	1 Tiburon® split drape with absorbent reinforcement, adhesive	4
29351N	1 Tiburon® top drape with absorbent reinforcement 53 x 99 in., adhesive	
9040N	2 Astound® impervious reinforced gown, X-large	
8520N	2 Absorbent towel	
8694-60	1 Suture bag	
8337N	1 Mayo stand cover, reinforced poly, 23 in. wide	
8475N	1 U-Drape, poly, adhesive, 60 x 84 in.	
1582N	1 Stockinette, 12 x 48 in., X-large	
8554N	4 Drape towel, adhesive, nonabsorbent	
8143N	1 Outer wrap, reinforced poly table cover, 50 x 90 in.	

Orthopedic Pack**Cat. No. 29182**

NS Cat. No.	Contents	Qty. Cs
9349N	1 Astound™ fan-folded drape sheet, 60 x 76 in.	5
29436N	1 Tiburon® split drape, adhesive	
8694-60	1 Suture bag	
8337N	1 Mayo stand cover, reinforced poly, 23 in. wide	
8476NA	1 Prep U-drape, 60 x 72 in.	
A8554N	4 Drape towel, adhesive, nonabsorbent	
A8143N	1 Outer wrap, reinforced poly table cover, 50 x 90 in.	

Orthopedic Pack

Cat. No. 29183

NS Cat. No.	Contents	Qty. Cs
9349N	1 Astound™ fan-folded drape sheet, 60 x 76 in.	5
8520N	1 Absorbent towel	
8694-60	1 Suture bag	
8337N	1 Mayo stand cover, reinforced poly, 23 in. wide	
8376N	1 Plastic sheet, fan-folded, 44 x 75 in.	
8554N	4 Drape towel, adhesive, nonabsorbent	
29436N	1 Tiburon® Split Drape 77 x 108 in.	
8143N	1 Outer wrap, reinforced poly table cover, 50 x 90 in.	

Hand and Hip Packs

Hand Pack

Cat. No. 9419

NS Cat. No.	Contents	Qty. Cs
29419N	1 Tiburon® hand drape	5
8694-60	1 Suture bag	
8337N	1 Mayo stand cover, reinforced poly, 23 in. wide	
8476NA	1 Prep U-drape, 60 x 72 in.	
8143N	1 Outer wrap, reinforced poly table cover, 50 x 90 in.	

Hip Pack

Cat. No. 29187

NS Cat. No.	Contents	Qty. Cs
29430N	1 Tiburon® hip drape	6
9040N	2 Astound® gown, impervious reinforced, X-large	
8520N	2 Absorbent towel	
8694-60	1 Suture bag	
8337N	1 Mayo stand cover, reinforced poly, 23 in. wide	
8475N	1 U-Drape, poly, adhesive, 60 x 84 in.	
1582N	1 Stockinette, 12 x 48 in., X-large	
8554N	2 Drape towel, adhesive, nonabsorbent	
8143N	1 Outer wrap, reinforced poly table cover, 50 x 90 in.	

Arthroscopic Packs

Arthroscopy Pack II for Dropped Leg Procedures **Cat. No. 9185**

NS Cat. No.	Contents	Qty. Cs
9414NA	1 Tiburon® arthroscopy drape with pouch for dropped leg procedures	6
32474N	1 SmartGown™ gown, fully impervious, X-large and X-long	
90270NA	1 Astound® standard scrub nurse gown, large with towel and wrap	
8694-60	1 Suture bag	
8337N	1 Mayo stand cover, reinforced poly, 23 in. wide	
8476NA	2 Prep U-drape, 60 x 72 in.	
1586N	1 Impervious stockinette, 9 x 48 in., large	
3524	4 Drape Tape	
8143N	1 Outer wrap, reinforced poly table cover, 50 x 90 in.	

Arthroscopy Pack III**Cat. No. 9187**

NS Cat. No.	Contents	Qty. Cs
9413NA	1 Tiburon® arthroscopy drape with pouch for dropped and straight leg procedures	6
32474N	1 SmartGown™ gown, fully impervious, X-large and X-long	
90270NA	1 Astound® standard scrub nurse gown, large, with towel in outer wrap	
8694-60	1 Suture bag	
8337N	1 Mayo stand cover, reinforced poly, 23 in. wide	
8476NA	1 Prep U-drape, 60 x 72 in.	
1586N	1 Impervious stockinette, 9 x 48 in., large	
3524	4 Drape tape	
8143N	1 Outer wrap, reinforced poly table cover, 50 x 90 in.	

Arthroscopy Pack**Cat. No. 29180**

NS Cat. No.	Contents	Qty. Cs
29415N	1 Tiburon® extremity drape with absorbent reinforcement	6
9040N	1 Astound® gown, impervious reinforced, X-large	
8520N	1 Absorbent towel	
8694-60	1 Suture bag	
8337N	1 Mayo stand cover, reinforced poly, 23 in. wide	
8476NA	1 Prep U-drape, 60 x 72 in.	
1582N	1 Impervious stockinette, 12 x 48 in, X-large	
8143N	1 Outer wrap, reinforced poly table cover, 50 x 90 in.	

Arthroscopy Pack

Cat. No. 29186

NS Cat. No.	Contents	Qty. Cs
29415N	1 Tiburon® extremity drape with absorbent reinforcement	6
32474N	1 SmartGown™ gown, fully impervious, X-large and X-long	
90270NA	1 Astound® standard scrub nurse gown, large, with towel in outer wrap	
8694-60	1 Suture bag	
8337N	1 Mayo stand cover, reinforced poly, 23 in. wide	
8476NA	2 Prep U-drape, 60 x 72 in.	
1586N	1 Impervious stockinette, 9 x 48 in., large	
3524	4 Drape tape	
8143N	1 Outer wrap, reinforced poly table cover, 50 x 90 in.	

Extremity Packs

Extremity Pack

Cat. No. 29188

NS Cat. No.	Contents	Qty. Cs
29414N	1 Tiburon® extremity drape	5
8694-60	1 Suture bag	
8337N	1 Mayo stand cover, reinforced poly, 23 in. wide	
8375N	1 Plastic sheet, fan-folded, 44 x 60 in.	
8554N	2 Drape towel, adhesive, nonabsorbent	
8143N	1 Outer wrap, reinforced poly table cover, 50 x 90 in.	

Extremity Pack

Cat. No. 29189

NS Cat. No.	Contents	Qty. Cs
29414N	1 Tiburon® extremity drape	6
8694-60	1 Suture bag	
9040N	2 Astound® gown, impervious reinforced, X-large	
8520N	1 Absorbent towel	
8337N	1 Mayo stand cover, reinforced poly, 23 in. wide	
8375N	1 Plastic sheet, fan-folded, 44 x 60 in.	
8554N	3 Drape towel, adhesive, nonabsorbent	
8143N	1 Outer wrap, reinforced poly table cover, 50 x 90 in.	

Shoulder Packs

Fluid Control Shoulder Pack

Cat. No. 9183

NS Cat. No.	Contents	Qty. Cs
9360N	1 Tiburon® shoulder drape with attached fluid control pouch, with incise	3
9361N	1 Tiburon® split drape, poly reinforced, adhesive	
32474N	1 SmartGown™ gown, fully impervious, X-large and X-long	
90270NA	1 Astound® standard scrub nurse gown, large, with towel in outer wrap	
8694-60	1 Suture bag	
8337N	1 Mayo stand cover, reinforced poly, 23 in. wide	
8554N	4 Drape towel, adhesive, nonabsorbent	
8146N	1 Outer wrap, reinforced poly table cover, 44 x 90 in.	

Fluid Control Shoulder Drape Pack

Cat. No. 29367

NS Cat. No.	Contents	Qty. Cs
9360N	1 Tiburon® shoulder drape with attached fluid control pouch, with incise	10
9361N	1 Tiburon® split drape, poly reinforced, adhesive	

Shoulder Drape Pack

Cat. No. 29365

NS Cat. No.	Contents	Qty. Cs
9361N	1 Tiburon® split drape, poly reinforced, adhesive	8
29365N	1 Tiburon® shoulder drape with incise, adhesive	

Shoulder Pack

Cat. No. 29160

NS Cat. No.	Contents	Qty. Cs
9361N	1 Tiburon® split drape, poly reinforced, adhesive	3
29365N	1 Tiburon® shoulder drape with incise, adhesive	
32474N	1 SmartGown™ gown, fully impervious, X-large and X-long	
90270NA	1 Astound® standard scrub nurse gown, large, with towel in outer wrap	
8520N	1 Absorbent towel	
8694-60	1 Suture bag	
8337N	1 Mayo stand cover, reinforced poly, 23 in. wide	
8476NA	1 U-Drape, poly, adhesive, 60 x 72 in.	
8554N	4 Drape towel, adhesive, nonabsorbent	
8146N	1 Outer wrap, reinforced poly table cover, 44 x 90 in.	

Pediatrics

Pediatric Pack

Pediatric Pack

Cat. No. 29490

NS Cat. No.	Contents	Qty. Cs
29493N	1 Tiburon® pediatric drape	8
9545NA	2 Astound® standard gown, sterile back, X-large	
8520N	2 Absorbent towel	
8337N	1 Mayo stand cover, reinforced poly, 23 in. wide	
8694-60	1 Suture bag	
8554N	4 Drape towel, adhesive, nonabsorbent	
8146N	1 Outer wrap, reinforced poly table cover, 44 x 90 in.	

Peri-GYN

Laparoscopy Packs

Laparoscopy Pack

Cat. No. 29242

NS Cat. No.	Contents	Qty. Cs
29402N	1 Tiburon® laparoscopy drape with absorbent reinforcement, adhesive	10
8554N	1 Drape towel, adhesive, nonabsorbent	
8520N	1 Absorbent towel	
8421N	1 Pair of leggings, X-large	
8694-60	1 Suture bag	
8146N	1 Outer wrap, reinforced poly table cover, 44 x 90 in.	

Laparoscopy Pack

Cat. No. 29245

NS Cat. No.	Contents	Qty. Cs
29402N	1 Tiburon® laparoscopy drape with absorbent reinforcement, adhesive	8
8483N	1 Under-buttocks drape, reinforced poly	
90270NA	1 Astound® standard scrub nurse gown, large, with towel in outer wrap	
9515NA	1 Astound® standard gown, sterile back, large	
8554N	1 Drape towel, adhesive, nonabsorbent	
8520N	1 Absorbent towel	
8421N	1 Pair of leggings, X-large	
8337N	1 Mayo stand cover, reinforced poly, 23 in. wide	
8694-60	1 Suture bag	
8146N	1 Outer wrap, reinforced poly table cover, 44 x 90 in.	

Standard Packs

Laparoscopy/Pelviscopy Pack I**Cat. No. 29606**

NS Cat. No.	Contents	Qty. Cs
29404N	1 Tiburon® laparoscopy/pelviscopy drape with gussets, absorbent reinforcement, adhesive	10
8483N	1 Under-buttocks drape, reinforced poly	
8421N	1 Pair of leggings, X-large	

Laparoscopy/Pelviscopy Pack II**Cat. No. 29604**

NS Cat. No.	Contents	Qty. Cs
29404N	1 Tiburon® laparoscopy/pelviscopy drape with gussets, absorbent reinforcement, adhesive	10
8483N	1 Under-buttocks drape, reinforced poly	
8554N	2 Drape towel, adhesive, nonabsorbent	
8421N	1 Pair of leggings, X-large	
8694-60	1 Suture bag	
8337N	1 Mayo stand cover, reinforced poly, 23 in. wide	
8146N	1 Outer wrap, reinforced poly table cover, 44 x 90 in.	

Laparoscopy/Pelviscopy Pack III**Cat. No. 29408**

NS Cat. No.	Contents	Qty. Cs
29407N	1 Tiburon® laparotomy/pelviscopy drape	10
8483N	1 Under-buttocks drape, reinforced poly	
8554N	2 Drape towel, adhesive, nonabsorbent	
8421N	1 Pair of leggings, X-large	
8694-60	1 Suture bag	
8337N	1 Mayo stand cover, reinforced poly, 23 in. wide	
8146N	1 Outer wrap, reinforced poly table cover, 44 x 90 in.	

Fluid Control Laparoscopy Drape Pack**Cat. No. 29503**

NS Cat. No.	Contents	Qty. Cs
29403N	1 Tiburon® laparoscopy drape	10
8421N	1 Pair of leggings, X-large	

Abdominal Lithotomy Pack**Cat. No. 29146**

NS Cat. No.	Contents	Qty. Cs
29300N	1 Tiburon® abdominal lithotomy drape	8
8483N	1 Under-buttocks drape, reinforced poly	

Peri-GYN and Laparoscopy Packs

Peri-GYN Pack

Cat. No. 29276

NS Cat. No.	Contents	Qty. Cs
29438N	1 Tiburon® lithotomy "T" drape with absorbent reinforcement, adhesive	10
8554N	1 Drape towel, adhesive, nonabsorbent	
8520N	1 Absorbent towel	
8421N	1 Pair of leggings, X-large	
8694-60	1 Suture bag	
8146N	1 Outer wrap, reinforced poly table cover, 44 x 90 in.	

Peri-GYN Pack

Cat. No. 29170

NS Cat. No.	Contents	Qty. Cs
29450N	1 Tiburon® lithotomy drape with absorbent reinforcement, attached leggings	12
8483N	1 Under-buttocks drape, reinforced poly	
8554N	1 Drape towel, adhesive, nonabsorbent	
8520N	1 Absorbent towel	
8694-60	1 Suture bag	
8149N	1 Outer wrap/reinforced poly table cover, 44 x 85 in., reinforcement 24 x 85 in.	

Peri-GYN Pack

Cat. No. 29171

NS Cat. No.	Contents	Qty. Cs
29450N	1 Tiburon® lithotomy drape with absorbent reinforcement, attached leggings	5
8483N	1 Under-buttocks drape, reinforced poly	
9515NA	1 Astound® standard gown, sterile back, large	
8554N	1 Drape towel, adhesive, nonabsorbent	
8520N	1 Absorbent towel	
8694-60	1 Suture bag	
8149N	1 Outer wrap/reinforced poly table cover, 44 x 85 in., reinforcement 24 x 85 in.	

LAVH/Laparoscopy Pack

Cat. No. 29475

NS Cat. No.	Contents	Qty. Cs
29474N	1 Tiburon® LAVH drape	4
8483N	1 Under-buttocks drape, reinforced poly	
90680NA	1 Astound® scrub nurse gown, impervious reinforced, large, with towel in outer wrap	
9040N	2 Astound® gown, impervious reinforced, X-large	
8694-60	1 Suture bag	
8337N	1 Mayo stand cover, reinforced poly, 23 in. wide	
8143N	1 Outer wrap, reinforced poly table cover, 50 x 90 in.	

Standard Packs

Peri-GYN Pack

Cat. No. 9274

NS Cat. No.	Contents	Qty. Cs
9359N	1 Drape sheet, adhesive 38½ x 56 in.	10
8483N	1 Under-buttocks drape	
8421N	1 Pair of leggings, X-large	
8520N	1 Absorbent towel	
8554N	1 Non-absorbent towel with adhesive strip	
8694-60	1 Suture bag	
9515NA	1 Astound® standard gown, sterile back, large	
8146N	1 Table cover, reinforced poly, 44 x 90 in.	

Peri-GYN Pack

Cat. No. 9165

NS Cat. No.	Contents	Qty. Cs
9359N	1 Drape sheet, adhesive 38½ x 56 in.	12
8483N	1 Under-buttocks drape, reinforced poly	
8421N	1 Pair of leggings, X-large	
8520N	1 Absorbent towel	
8554N	1 Non-absorbent towel with adhesive strip	
8694-60	1 Suture bag	
8146N	1 Outer wrap, reinforced poly table cover, 44 x 90 in.	

Catalog Number Index

114.....	26, 46, 70	9131.....	26, 72
117.....	26, 46, 70	9133.....	60
119.....	26, 29, 50	9135.....	32, 76
599.....	6	9139.....	32, 77
1584.....	12	9150.....	22, 77
1585.....	12	9154.....	20
1586.....	12	9155.....	20
1587.....	12	9156.....	20
1590SSA.....	12	9158.....	20
3175.....	6	9162.....	20
3520.....	10	9165.....	67, 90
3523.....	10	9183.....	57, 86
3524.....	10, 52, 55, 81, 82, 84, 85	9185.....	52, 84
7444.....	41	9187.....	52, 84
7445.....	41	9194.....	43, 80
7552.....	10	9195.....	43, 80
7553.....	10	9196.....	43, 81
7554.....	10	9197.....	47, 82
8145W.....	10	9199.....	43, 81
8146W.....	10	9274.....	67, 90
8184W.....	10	9349.....	11
8186.....	11	9355.....	11
8186W.....	11	9358.....	11
8337.....	11	9385.....	10
8339.....	11	9412.....	30
8376.....	10	9413.....	50
8377.....	10	9414.....	50
8378.....	10	9418.....	30
8380.....	10	9419.....	52, 83
8385.....	11	9423.....	50
8386.....	11	9428.....	31
8420.....	12	9430.....	29
8421.....	12	9438.....	31
8430.....	12	9439.....	34
8433.....	12	9444.....	11
8441.....	42	9446.....	11
8461.....	12	9447.....	42
8474.....	12	9448.....	34
8475.....	12	9449.....	34
8476.....	12	9450.....	34
8482.....	12	9457.....	31
8483.....	12	9458.....	31
8484.....	12	9461.....	11
8486.....	12	9462.....	10
8553.....	10	9520E.....	24, 79
8750.....	11	9556.....	42
9100.....	26, 70	9562.....	41
9101.....	26, 70	9565.....	41
9102.....	26, 70	9777.....	60
9103.....	26, 71	29013.....	15
9106.....	28, 73	29107.....	28, 73
9109.....	26, 71	29118.....	28, 73
9111.....	26, 71	29120.....	32, 76
9112.....	26, 71	29121.....	32, 76
9113.....	26, 72	29127.....	32, 74
9114.....	26, 72	29130.....	32, 75
9120.....	32, 77	29131.....	28, 74

Catalog Number Index

29133	28, 74	29445	49
29136	32, 75	29446	49
29137	32, 75	29447	36
29138	32, 75	29448	36
29140	32, 76	29449	36
29146	67, 88	29450	66
29153	22, 78	29452	36
29154	20	29455	24, 65
29158	22, 78	29456	14
29160	57, 86	29458	15
29170	67, 89	29459	15
29171	67, 89	29460	14
29180	55, 84	29461	15
29181	49, 82	29470	24, 79
29182	49, 82	29471	24, 79
29183	49, 83	29474	66
29186	55, 85	29475	67, 89
29187	52, 83	29476	48
29188	55, 85	29480	24, 79
29189	55, 85	29490	61, 87
29242	67, 87	29492	60
29245	67, 87	29493	60
29276	67, 89	29494	60
29322	16	29496	30
29350	11	29499	30
29352	27, 56	29503	67, 88
29360	24, 79	29510	29
29365	57, 86	29520	14
29367	57, 86	29521	15
29369	56	29522	30
29405	53	29525	16
29407	65	29527	16
29408	67, 88	29529	17
29410	29	29556	14
29411	29	29559	16
29412	53	29560	14
29413	53	29570	14
29414	53	29604	67, 88
29415	53	29606	67, 88
29416	54	29668	16
29417	54	29920	37, 80
29418	34	59180	47, 81
29420	31	59352	46
29421	29	59405	46
29422	30	59413	46
29425	29	59438	46
29427	51	59439	46
29430	50	74210	60
29431	48	94590	31
29433	48	SPP99GSUDA	10
29434	48, 60	TB9349CE	11
29435	53	TB9355CE	11
29436	48	TB9358CE	11
29439	50	TB9441	42
29440	27, 48		
29443	36		
29444	50		

Nonsterile Index

1582N	12, 26, 47, 49, 52, 55, 81, 82, 83, 84
1585N	12
1586N	12, 52, 55, 84, 85
3524N	26, 47
7148N	32, 77
7444N	41
7445N	41
7554N	10, 22, 78
8143N	22, 26, 28, 32, 49, 52, 55, 67, 70, 71, 72, 74, 75, 77, 78, 82, 83, 84, 85, 89
8145N	10, 24, 37, 79, 80
8145NW	10
8146N	10, 26, 28, 32, 43, 57, 61, 67, 70, 71, 72, 73, 74, 75, 76, 77, 80, 81, 86, 87, 88, 89, 90
8146NW	10
8149N	67, 89
8152N	11, 22, 78
8153N	11
8184N	10
8184NW	10
8186N	11, 26, 47, 70, 72, 81, 82
8186NW	11
8187N	10
8188N	10, 22, 78
8191N	10
8337N	11, 22, 26, 28, 32, 43, 47, 49, 52, 55, 57, 61, 67, 70, 71, 72, 73, 74, 75, 76, 77, 78, 80, 81, 82, 83, 84, 85, 86, 87, 88, 89
8339NI	11
8365N	10, 37, 80
8375N	55, 85
8376N	49, 83
8420NA	12
8421N	12, 24, 37, 67, 79, 80, 87, 88, 89, 90
8430NA	12
8433N	12
8441N	42
8461N	12
8470N	11, 22, 78
8474N	12, 47, 81, 82
8475N	12, 49, 52, 82, 83
8476NA	12, 26, 47, 49, 52, 55, 57, 81, 82, 83, 84, 85, 86
8482N	12
8483N	12, 37, 67, 80, 87, 88, 89, 90
8484N	12
8486N	12
8520N	10, 22, 24, 26, 28, 32, 37, 43, 47, 49, 52, 55, 57, 61, 67, 71, 72, 73, 74, 75, 76, 77, 78, 79, 80, 81, 82, 83, 84, 85, 86, 87, 89, 90
8554N	10, 22, 26, 28, 32, 43, 49, 52, 55, 57, 61, 67, 70, 71, 72, 73, 74, 75, 76, 77, 78, 80, 81, 82, 83, 85, 86, 87, 88, 89, 90
8694-60	22, 24, 26, 28, 32, 43, 47, 49, 52, 55, 57, 61, 67, 70, 71, 72, 73, 74, 75, 76, 77, 78, 79, 80, 81, 82, 83, 84, 85, 86, 87, 88, 89, 90
9010N	6, 26, 32, 72, 75
9011ELN	4
9011N	4
9040N	6, 22, 49, 52, 55, 67, 78, 82, 83, 84, 85, 89
9041ELN	4
9041N	4
9070N	6
9071ELN	4
9071N	4
9150N	21, 22, 77
9154N	20, 22, 78
9155N	20
9156N	20
9158N	20, 22, 78
9162N	20
9349N	11, 22, 26, 49, 70, 71, 72, 77, 78, 82, 83
9355N	11
9358N	11, 26, 32, 70, 71, 74, 75, 76
9359N	67, 90
9360N	56, 57, 86
9361N	49, 56, 57, 86
9412N	30, 32, 76, 77
9413NA	50, 52, 84
9414NA	50, 52, 84
9418N	30
9423N	50
9428NA	31
9430N	29
9438N	31
9439N	34
9441N	42, 43, 81
9442N	42, 43, 80
9443N	42, 43, 80
9444N	11
9446N	11
9447N	42, 43, 81
9448N	34
9449N	34
9450N	34
9457N	31
9458N	31, 32, 77
9460N	10, 22, 78
9461N	11, 24, 79
9462N	10
9465N	27, 28, 73
9467N	27, 28, 73
9468N	27, 28, 73
9511N	6, 26, 32, 71, 74, 75
9515NA	5, 24, 26, 28, 32, 43, 67, 70, 71, 72, 73, 76, 77, 79, 80, 81, 87, 89, 90
9518NA	5
9541N	6, 22, 77
9545NA	5, 61, 87
9548NA	5
9556N	42, 43, 80, 81
9557N	43, 80
9560N	4
9562N	41
9565N	41

Nonsterile Number Index

9571N	6	29456N	14
9575NA	5	29458N	15
9578NA	5	29459N	15
9777N	60	29460N	14
29013N	15	29461N	15
29154N	20	29462N	21, 22, 78
29194N	27, 28, 74	29464N	21, 22, 78
29195N	27, 28, 74	29465NA	27, 28, 73
29300N	64, 67, 88	29467N	21, 22, 27, 28, 73, 78
29322N	16	29468N	21, 22, 78
29350N	11	29469N	27, 28, 73
29351N	27, 28, 49, 56, 74, 82	29474N	66, 67, 89
29357N	37, 80	29476N	48
29365N	56, 57, 86	29478N	56
29369NA	56	29489N	15
29402N	64, 67, 87	29492N	60
29403N	65, 67, 88	29493N	60, 61, 87
29404N	64, 67, 88	29494N	60
29405N	53	29496N	30
29407N	65, 67, 88	29499N	30
29410N	29, 32, 74, 75, 76	29510N	29
29411N	32, 76	29520N	14
29412N	53	29521N	15
29413N	53	29522N	30
29414N	53, 55, 85	29525N	16
29415N	53, 55, 84, 85	29527N	16
29417N	54	29529N	17
29418N	34	29556NA	14
29419N	52, 83	29557N	16
29420N	31	29559N	16
29421N	29, 32, 76	29560N	14
29422N	30	29570N	14
29427N	51	29665N	27, 28, 73
29430N	50, 52, 83	29667N	27, 28, 73
29431N	48	29668N	16
29432N	48, 49, 82	29669N	27, 28, 73
29434N	48, 60	32474N	4, 24, 47, 52, 55, 57, 79, 81, 82, 84, 85, 86
29435N	53	39015N	4
29436N	48, 49, 82, 83	39045N	4
29437NA	24, 79	39049N	4
29438N	66, 67, 89	39075N	4
29439N	50	39079N	4
29440NA	27, 28, 48, 74	39099N	4
29443N	36	59352N	46
29444N	50	59405N	46, 47, 81
29445N	49	59413N	46, 47, 82
29446N	49	59438N	46
29447N	36	59439N	46
29448N	36	74210N	60
29449N	36	89005N	4
29450N	66, 67, 89	89013N	4
29451N	24, 79	89015N	4, 43, 81
29452N	36	89045N	4
29453N	36	89075N	4
29455N	65	90020N	4
29455NA	24	90030N	4

Nonsterile Number Index

90270NA.....	5, 26, 28, 32, 43, 47, 52, 55, 57, 67, 70, 71, 72, 73, 76, 77, 80, 81, 82, 84, 85, 86, 87
90280NA.....	5
90370NA.....	5
90380NA.....	5
90680NA.....	6, 22, 26, 32, 67, 72, 75, 78, 89
90780N.....	6, 22, 78
90970N.....	6, 26, 71
91070N.....	6
94590N.....	31
95995N.....	5
95998N.....	5
890015N.....	4, 43, 81
890045N.....	4
A8143N.....	82
A8554N.....	82
ES5000N.....	40
ES5010N.....	40
ES5020N.....	40
ES5030N.....	40
ES5040N.....	40
ES5300N.....	40
ES5500N.....	41
ES6000N.....	41
FG71-2384C.....	47, 81, 82
TB9349NI.....	11
TB9358NI.....	11

Product Index

A

Aprons

Heavy-Duty Disposable Cystoscopy Apron6

C

Cord Management

Cord Management Tabs 12

Covers

Heavy-Duty Reinforced Back Table Covers..... 11
 Mayo Stand Covers 11
 Standard Reinforced Back Table Covers 10

D

Drapes

Angiography:

Extra Large Femoral Angiography Drape 14
 Femoral Angiography Drape with Single Pouch 16
 Femoral Angiography Drape with Trough 14
 Full Body Central Line Drape..... 16
 Full Body Central Line Insertion Drape..... 16
 Line Insertion Drape..... 16
 Line Insertion Draping System 16
 Pacemaker Drape 15
 PICC Line Insertion Drape 16
 Radial/Femoral Angiography Drape..... 17
 Tiburon® Brachial Angiography Drape 15
 Tiburon® Femoral Angiography Drape..... 14
 Tiburon® Femoral Angiography Drape with Catheter Pouch..... 15
 Tiburon® Femoral Angiography Drape with Dual Pouches 15
 Tiburon® Femoral Angiography Drape with Expanded Reinforcement 14

Cardiovascular:

Tiburon® Bottom Drape with Reinforcement..... 21
 Tiburon® Cardiovascular Drape..... 21
 Tiburon® Cardiovascular Incise Drape 20
 Tiburon® Cardiovascular Peri-Groin Drape..... 20
 Tiburon® Cardiovascular Split Drape..... 20
 Tiburon® Cardiovascular Split Drape with Pouches..... 20
 Tiburon® Cardiovascular Split Drape with Troughs..... 20
 Tiburon® Head, Side and Foot Drapes 21

Cystoscopy:

Astound™ Cystoscopy "T" Drape 24
 Astound™ Lithotomy Drape with Fluid Control Pouch..... 24
 Astound™ Urological Drape 24

General Surgery:

Astound™ Adolescent Laparotomy Drape 30
 Astound™ Minor Procedure Drape 30
 Tiburon® Bariatric Drape..... 31
 Tiburon® Chest/Breast Drape..... 31
 Tiburon® General Endoscopy Drape..... 31
 Tiburon® General Surgery Drape..... 30
 Tiburon® Head, Side and Foot Drape 27
 Tiburon® Laparoscopic Abdominal Drape 31
 Tiburon® Laparoscopic Cholecystectomy Drape with Pouches..... 31

Tiburon® Laparotomy Drape 29
 Tiburon® Laparotomy Drape with Pouches..... 29, 30
 Tiburon® Laparotomy Incise Drape 29
 Tiburon® Major Abdominal Drape with Pouches 31
 Tiburon® Pfannenstiel Laparotomy Drape 29
 Tiburon® Thyroid Drape 30
 Tiburon® Transverse Laparotomy Drape 29
 Tiburon® Universal Pack..... 27
 Tiburon® Universal Split Pack..... 27

Neurology:

Tiburon® Craniotomy Drape..... 34
 Tiburon® Craniotomy Split Drape..... 34
 Tiburon® Neurological Drape..... 34
 Tiburon® Universal Spine Drape 34

Obstetrics:

Astound™ Abdominal Cover 37
 Tiburon® Cesarean Birth Drape 36

Ophthalmology and EENT:

Astound™ Bar Drape 43
 Astound™ EENT Split Drape..... 42
 Astound™ Head/Bar Drape 42
 Astound™ Large EENT Split Drape 42
 Eyescape® ClearView Eye Drape with Pouch 41
 Eyescape® Medium Drape with Adhesive Aperture 40
 Eyescape® Medium Drape with Incise Film..... 41
 Eyescape® Medium Drape with Incise Film Pouch..... 41
 Eyescape® Medium Drape with Wide Adhesive Aperture 40
 Eyescape® Ophthalmic Drape..... 41
 Eyescape® Ophthalmic Drape with Pouch 41
 Eyescape® Refractive Drape..... 40
 Eyescape® Small Drape with Adhesive Aperture..... 40, 42
 Eyescape® Small Drape with Adhesive Aperture and Pouch..... 40
 Eyescape® Small Drape with Incise Film 40
 Tiburon® Large EENT Split Drape..... 42

Orthopedics:

Tiburon® Arthroscopy Drape for Dropped and Straight Leg Procedures 50
 Tiburon® Arthroscopy Drape for Dropped Leg Procedures 50
 Tiburon® Arthroscopy Drape with Armboard Covers 50
 Tiburon® Beach Chair Shoulder Drape 56
 Tiburon® Bilateral Limb Drape 54
 Tiburon® Extremity Drape 53
 Tiburon® Extremity Drape with Armboard Covers..... 53
 Tiburon® Hand Drape 51
 Tiburon® HD Arthroscopy Drape 46
 Tiburon® HD Extremity Drape..... 46
 Tiburon® HD Hip Drape with Pouches 46
 Tiburon® HD Split Drape..... 46
 Tiburon® HD Top Drape..... 46
 Tiburon® Hip Drape 50
 Tiburon® Hip Drape with Pouches 50
 Tiburon® Orthopedic Split Drape 48
 Tiburon® Shoulder Drape 56
 Tiburon® Split Drape 48
 Tiburon® Split Drape 48, 49, 56
 Tiburon® Split Sheet Drape..... 49
 Tiburon® Top Drape 56

Pediatrics:

Neonatal Drape..... 60
 Tiburon® Circumcision Drape 60
 Tiburon® Neonatal Drape 60
 Tiburon® Pediatric Directional Incision Drape 60
 Tiburon® Pediatric Drape 60
 Tiburon® Pediatric Drape with Armboard Covers..... 60
 Tiburon® Split Drape 60

Peri-GYN:

Astound™ Abdominal Lithotomy Drape..... 64
 Astound™ Laparoscopy Drape 64, 65
 Astound™ Laparoscopy/Pelviscopy Drape..... 64, 65
 Astound™ Lithotomy Drape 65, 66
 Astound™ Lithotomy “T” Drape..... 66
 Tiburon® LAVH Drape..... 66
 Poly U-Drapes 12
 Under-Buttocks Drapes..... 12

G

Gowns, Surgical

Astound® Fabric-Reinforced Gowns6
 Astound® Fabric-Reinforced Gowns, Scrub Nurse.....6
 Astound® Poly-Reinforced Gowns.....6
 Astound® Poly-Reinforced Gowns, Scrub Nurse6
 Astound® Standard Gowns5
 Astound® Standard Gowns, Scrub Nurse.....5
 RoyalSilk® Surgical Gowns.....5
 RoyalSilk® Surgical Gowns, Scrub Nurse5
 SmartGown™ Surgical Gowns.....4
 SmartGown™ Surgical Gowns, Scrub Nurse4
 SmartSleeve™ Surgical Gowns4
 SmartSleeve™ Surgical Gowns, Scrub Nurse4

L

Leggings

Leggings 12

P

Packs

Arthroscopic Packs..... 84
 Arthroscopy Hand and Hip Packs 52
 Basic Packs 26, 70, 71, 72
 Cardiovascular Packs 22, 77
 Cystoscopy Packs..... 24, 79
 Extremity Packs 55, 85
 General Endoscopy Packs..... 32
 General Ortho Packs..... 49
 Hand and Hip Packs..... 83
 Head and Neck Packs..... 43, 80
 Laparoscopy Packs 87
 Laparotomy Packs 32, 74, 75, 76, 77
 Obstetrical Packs 37, 80
 Orthopedic Packs 82
 Pediatric Pack..... 61, 87

Peri-GYN and Laparoscopy Packs 89
 Peri-GYN Packs 67
 Setup Packs..... 26, 70
 Shoulder Packs 57, 86
 Tiburon® HD Lower Extremity Packs..... 81
 Tiburon HD Packs 47
 Universal Packs 28, 73

S

Sheets

Drape Sheets..... 11
 Drape Sheet, Square-Folded 11
 Utility Drape Sheet..... 10

Sleeves

Sterile Disposable Sleeves.....6

Stockinettes

Impervious Stockinettes 12

T

Tabs

Cord Management Tabs 12

Tape

Drape Tape..... 10

Towels

Drape Towels..... 10

